

VAMITTOOLS Családi ház – 023-as típus



Maketrasztót (Rewell stb.) NE használjanak termékeinkhez, mert az oldószere kárt tehet az egyes alkotóelemekben (főleg a vékonyakban)! A következő ragasztókat ajánljuk: kék tubusos Új Technokol Rapid (acetonmentes), kétkomponenses ragasztó (Epoxy Rapid, Araldite stb.). Bővebb információ a ragasztással, festéssel stb.-vel kapcsolatban a minden termék oldalán elérhető általános tájékoztatóban van!

Az összerakást az oldalak külön-külön történő összerakásával kezdjük. Minden falrésznél a sima (fényes) oldal néz kifelé! Kövessük a képeken látható lépéseket. Célszerű az épület belső oldalára karton maszkolókat tenni, hogy a fény ne világítsa át az épület falait. A karton maszkolókat az útmutató külön nem jelzi!

1. oldal:

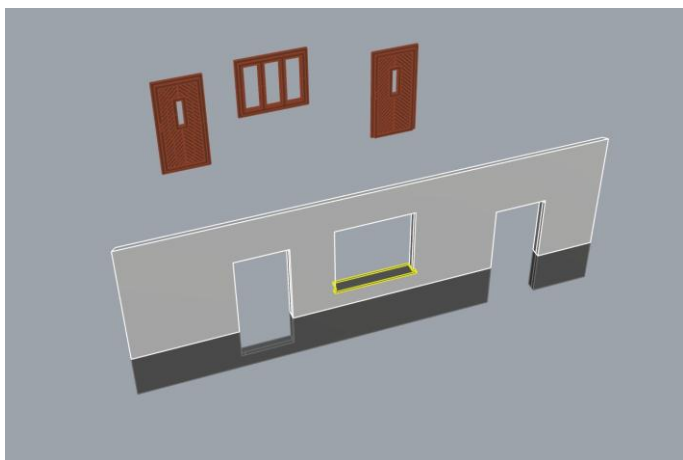
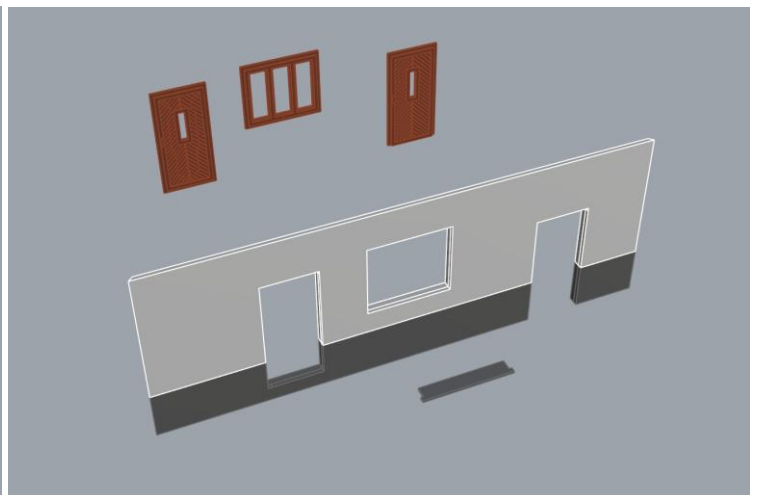
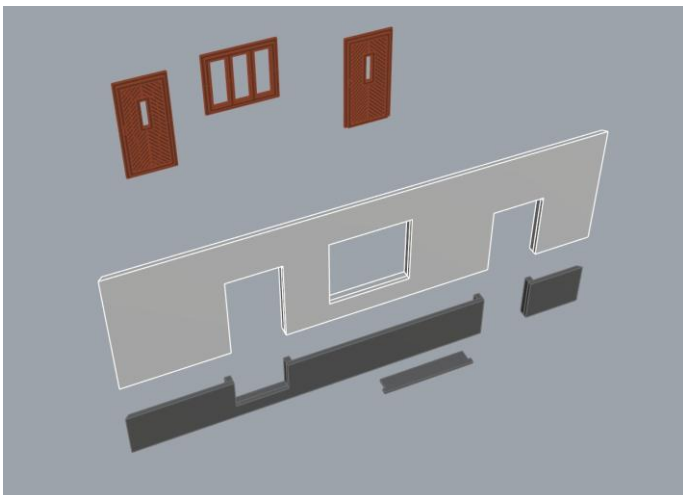

2. oldal:

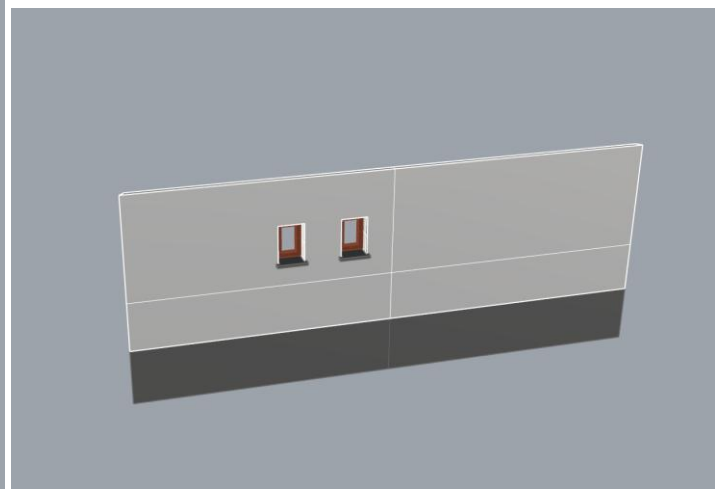
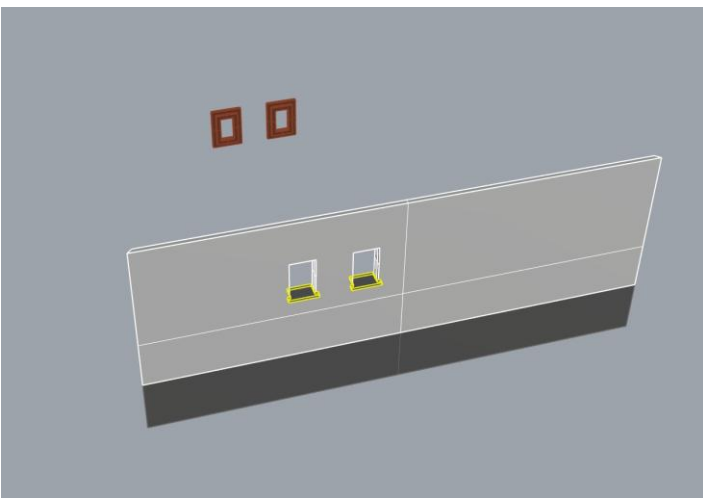
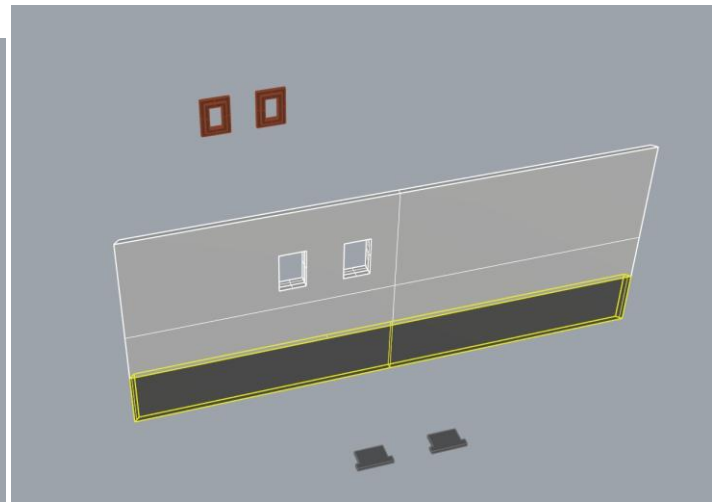
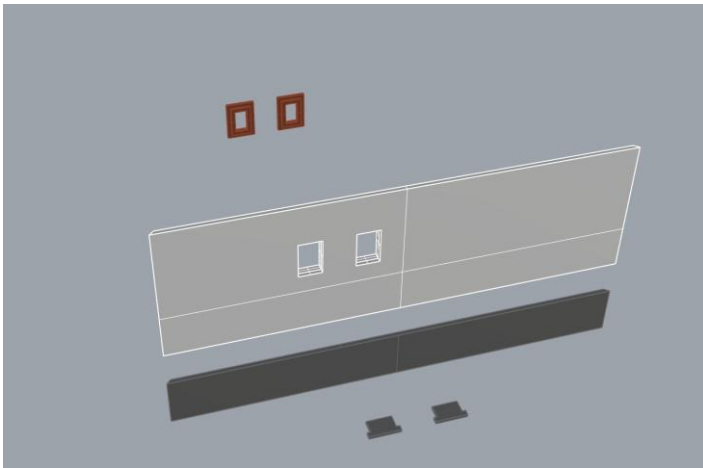

3. oldal:

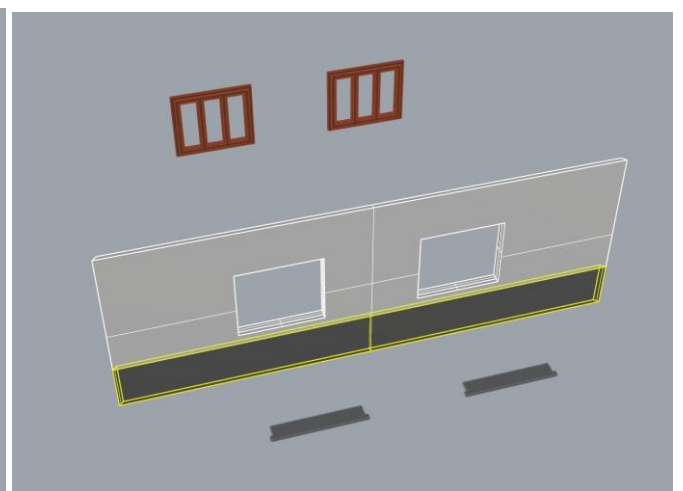
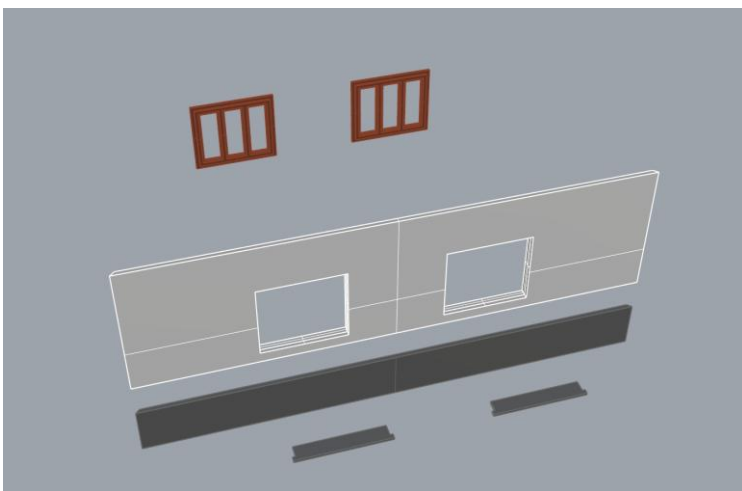

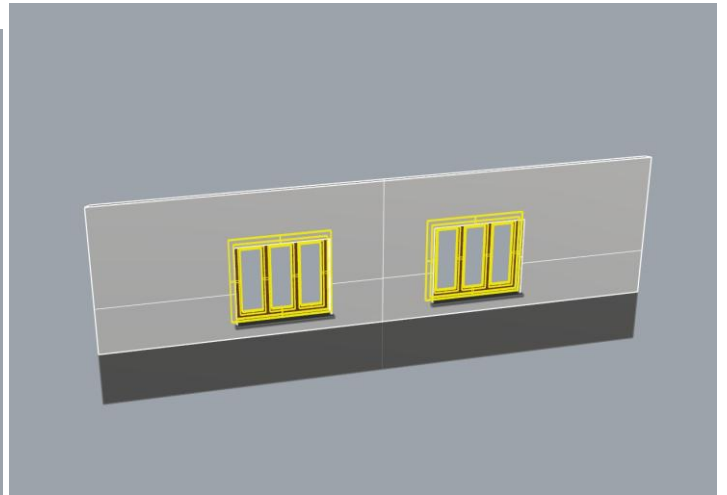
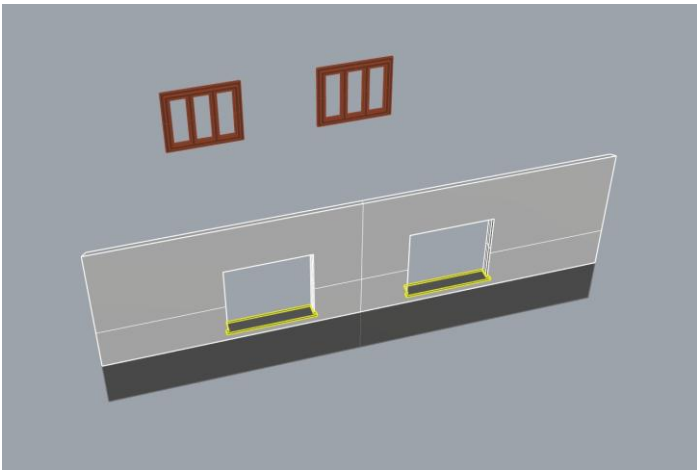

4. oldal:

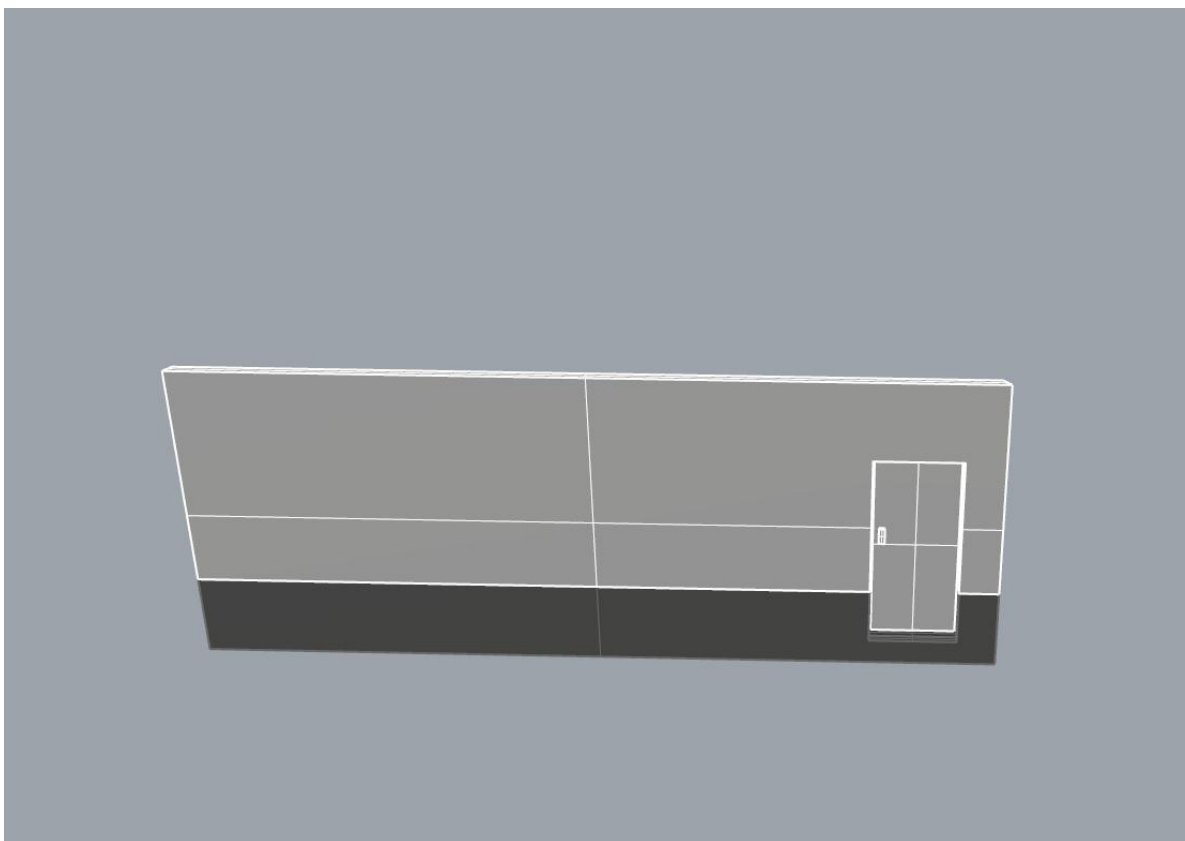
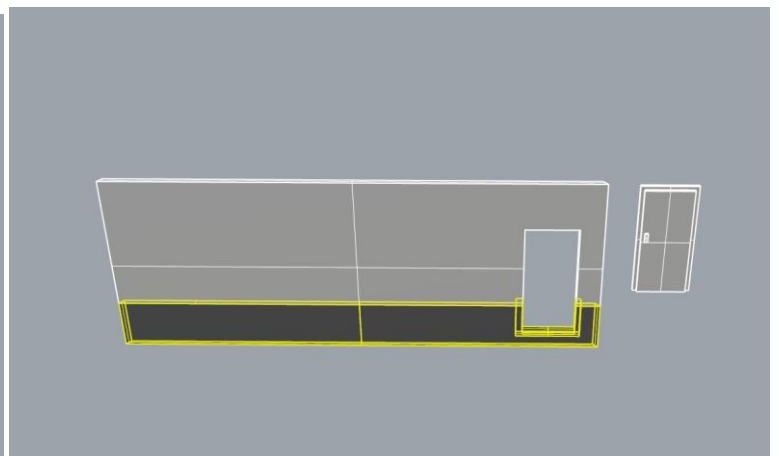
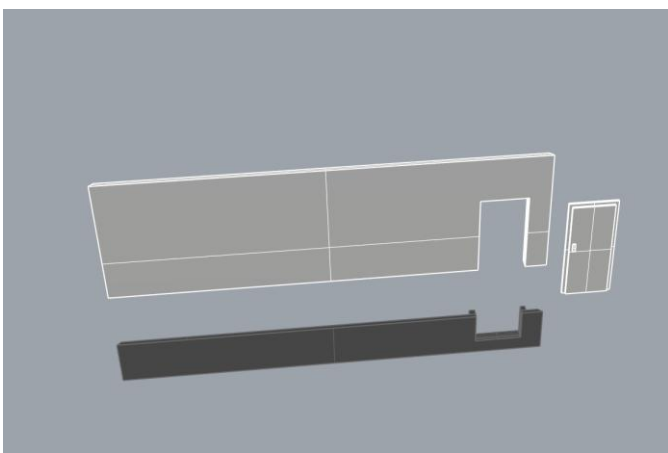

Ragasztási segédletként a falakat ragasszuk össze ideiglenesen az alábbi képen látható módon Scotch Magic- vagy Krepp takarószalaggal, így a falak a későbbi ragasztás során nem fognak elmozdulni. Egy-egy saroknál akár több helyen is megragaszthatjuk a ragasztószalaggal, így még biztosabb tartást kapunk. (A kép illusztráció)

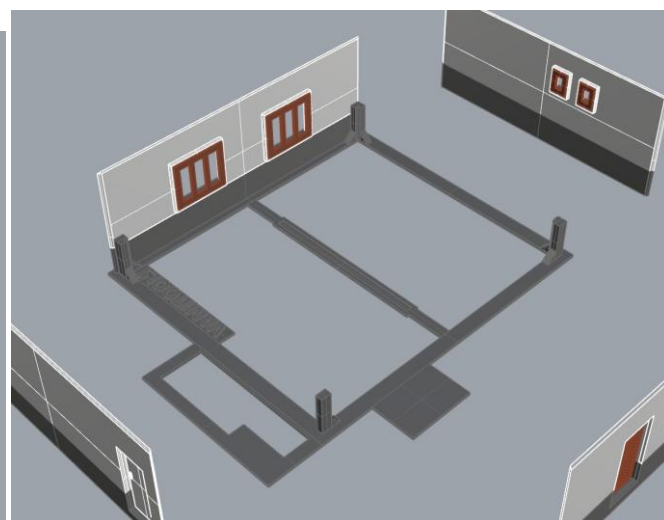
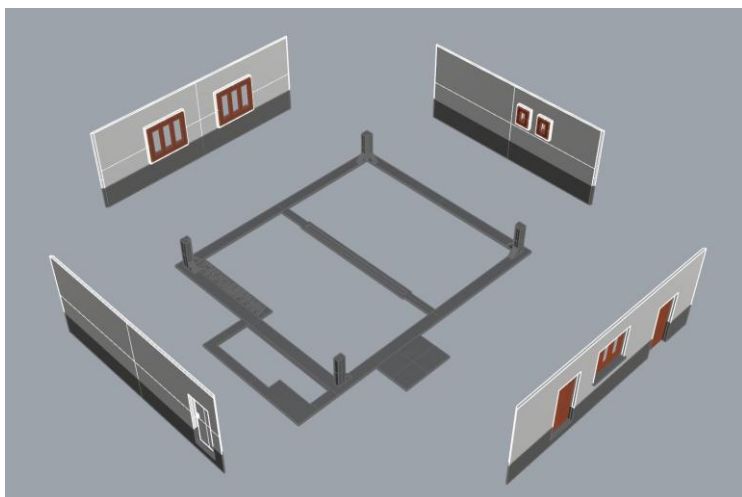
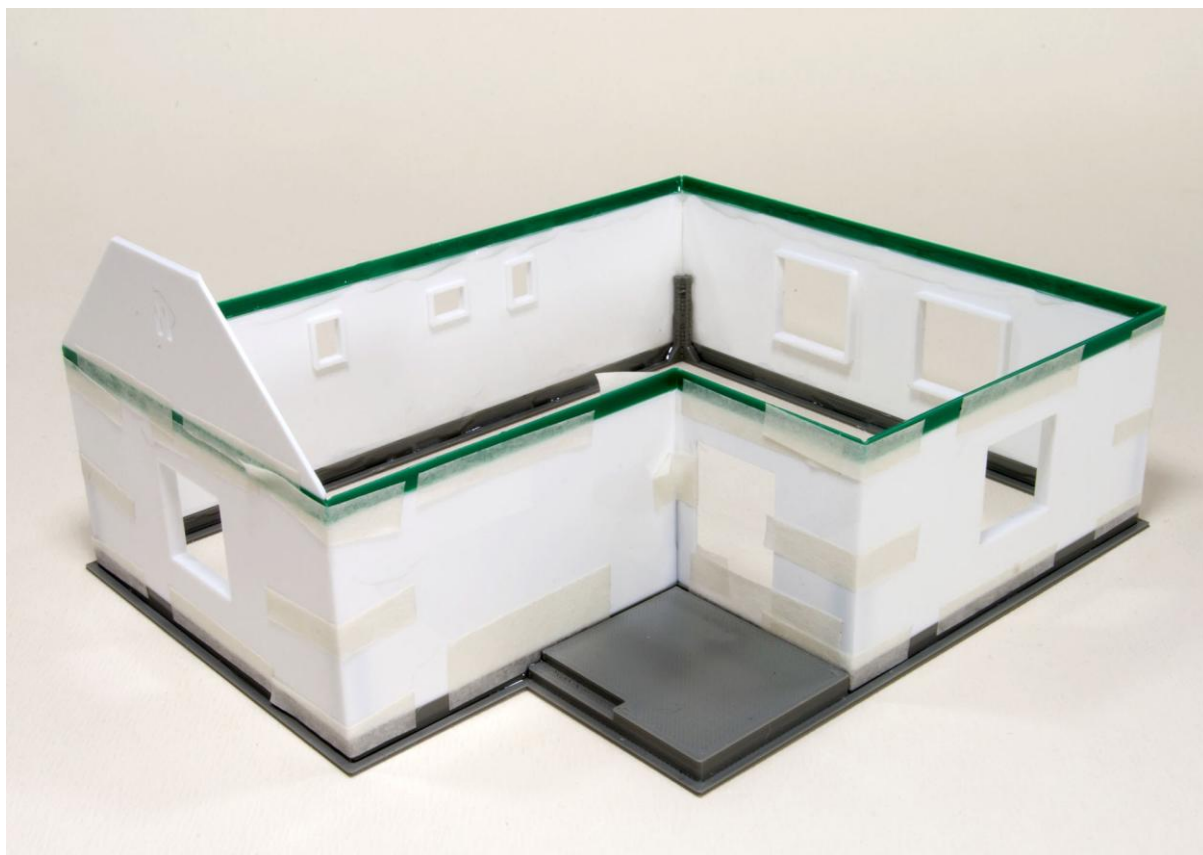

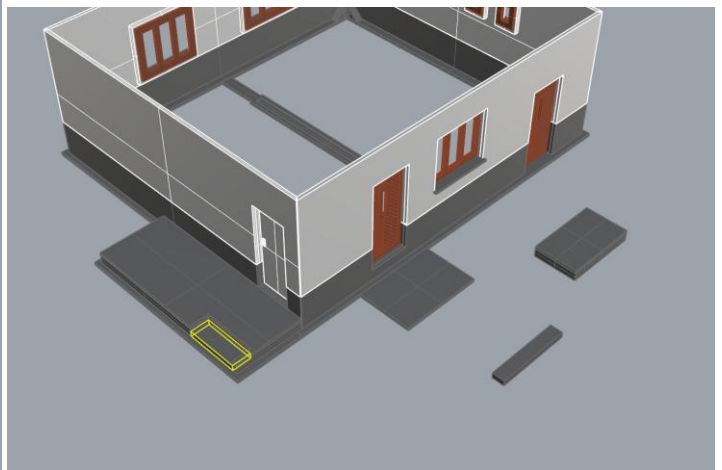
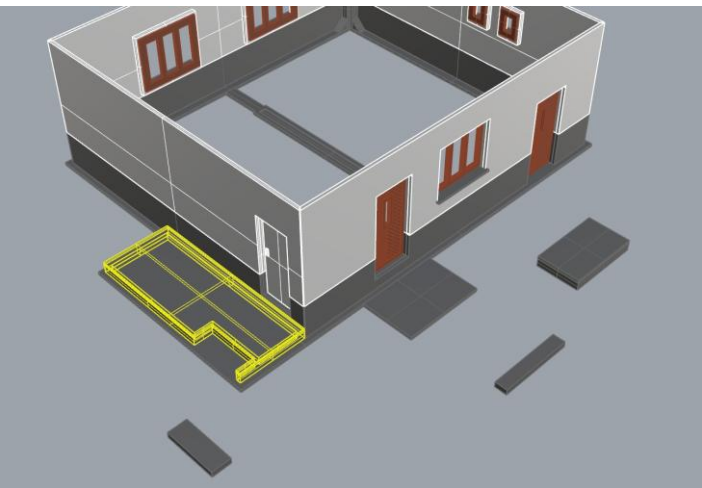
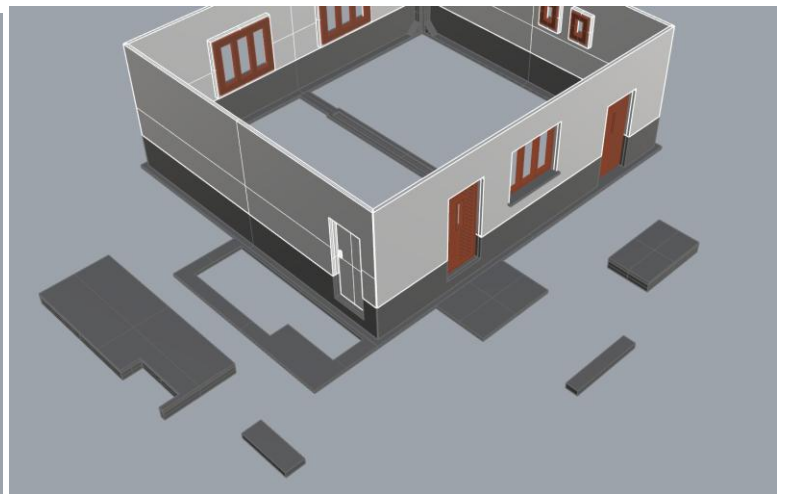
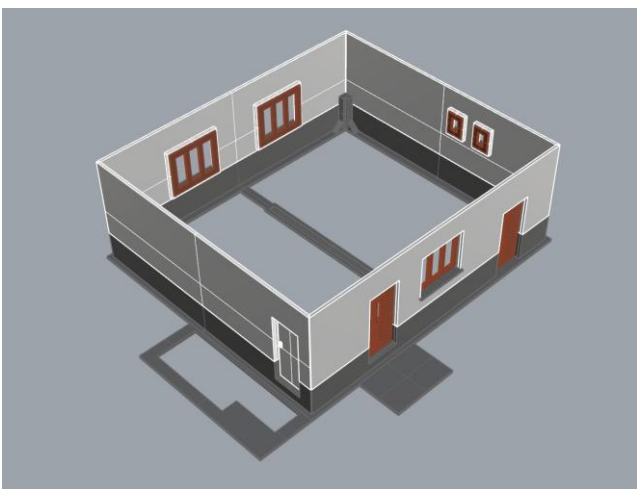
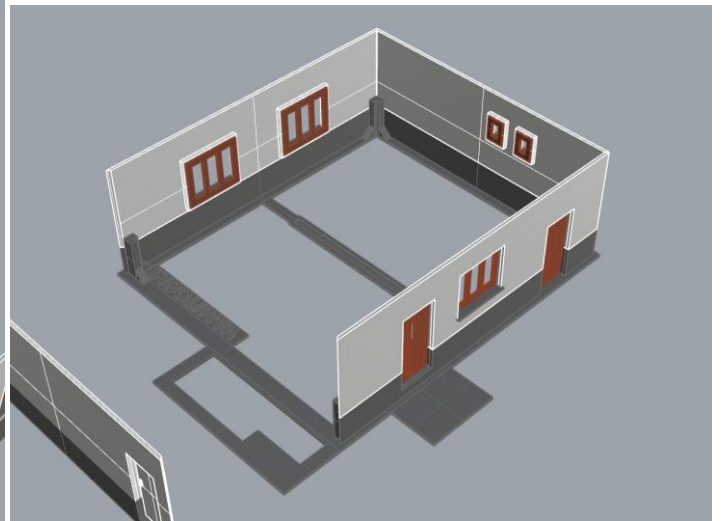
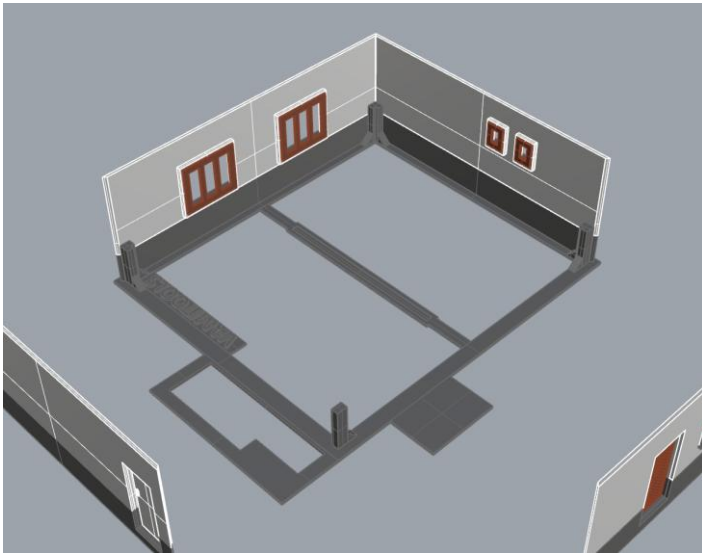

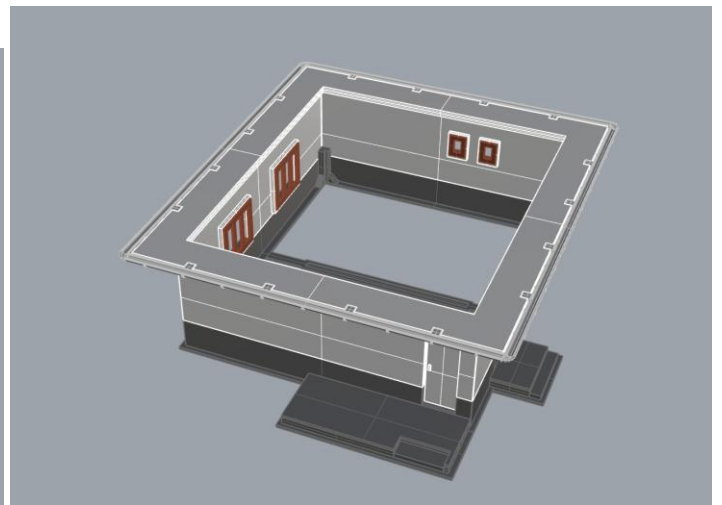
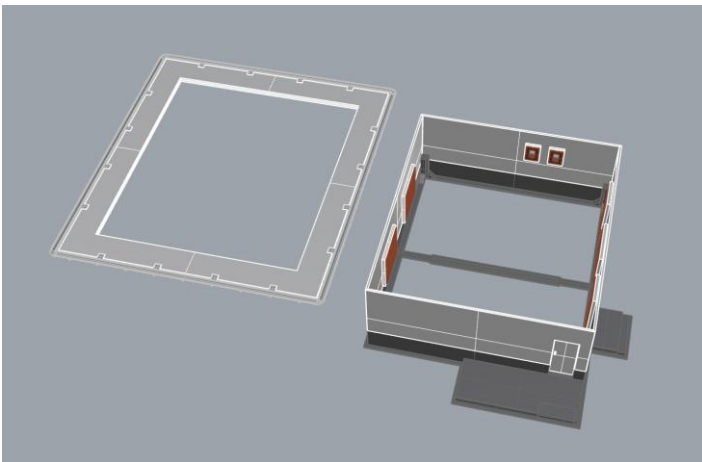
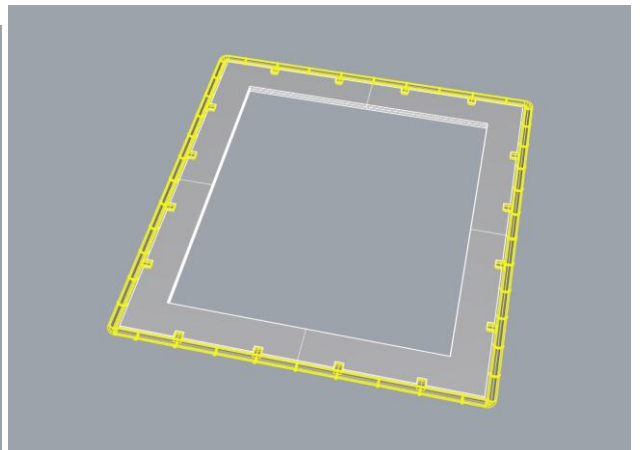
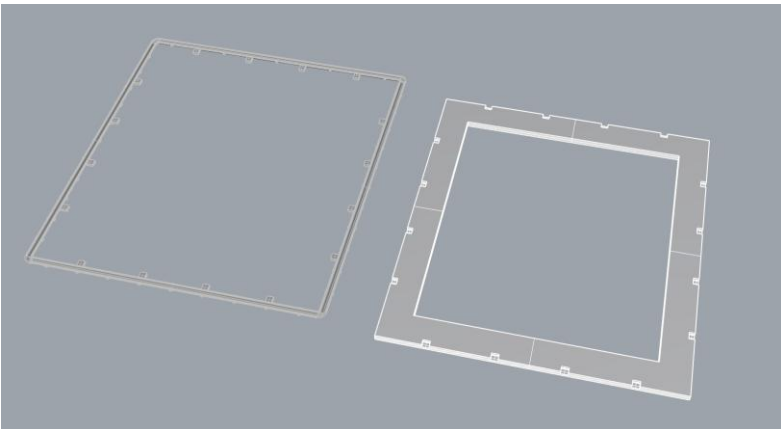
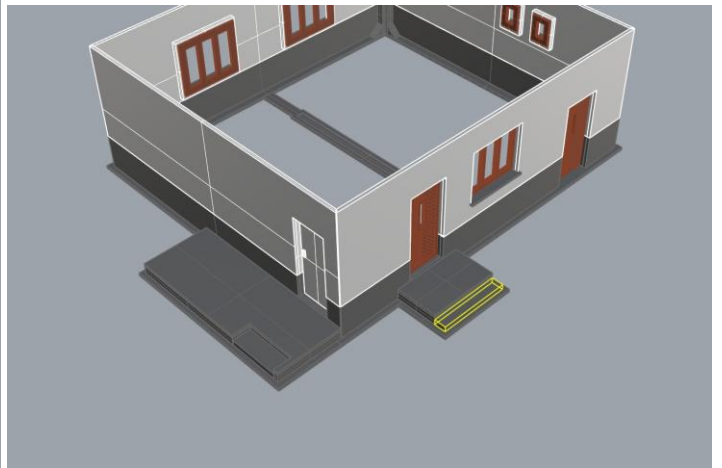
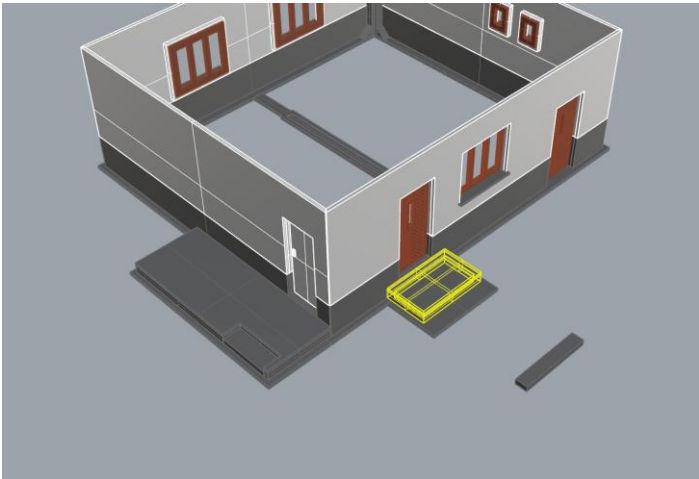

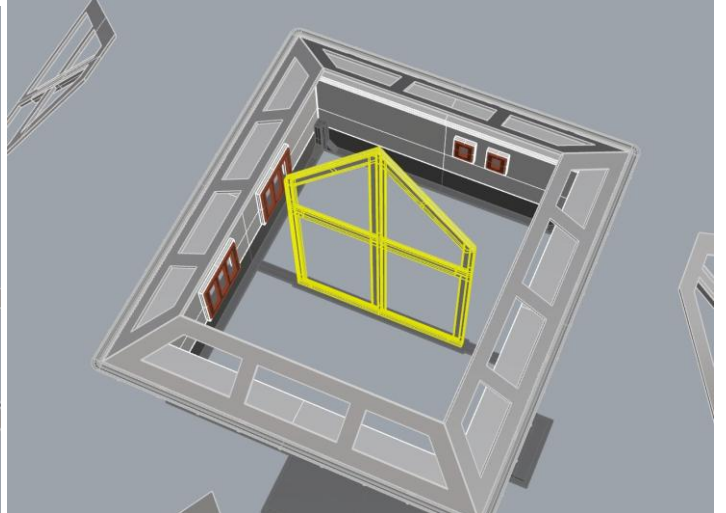
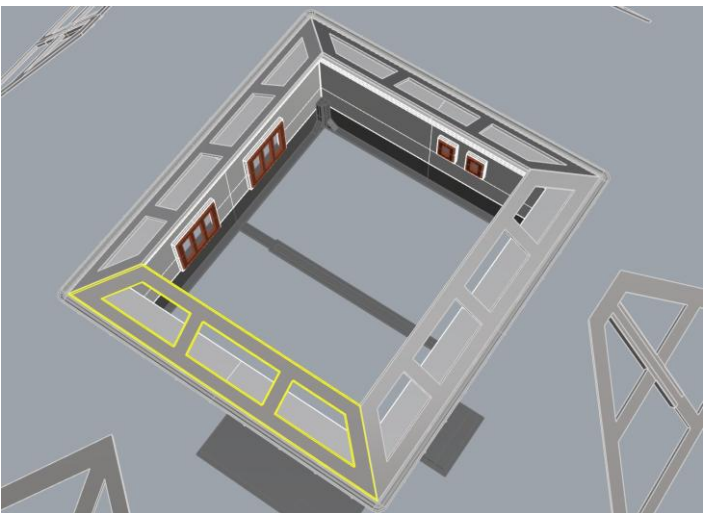
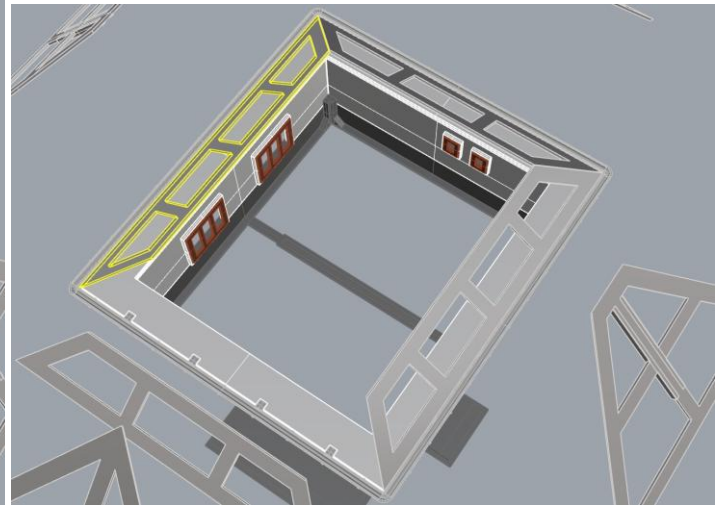
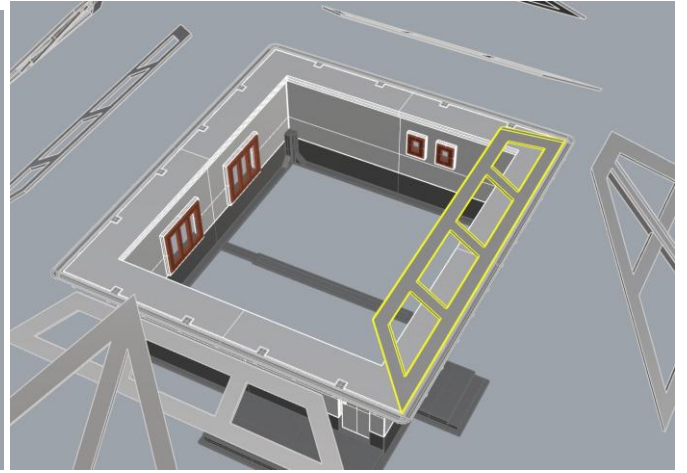
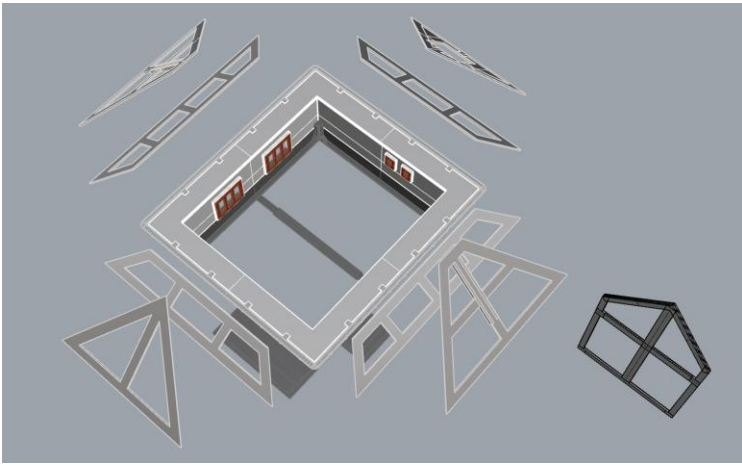

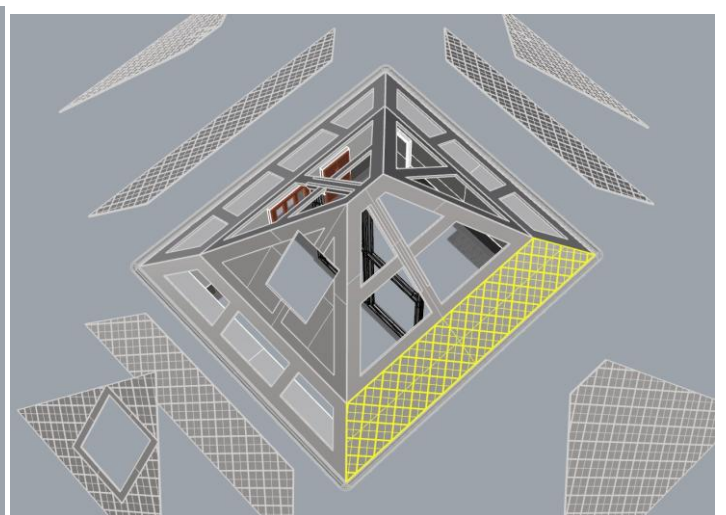
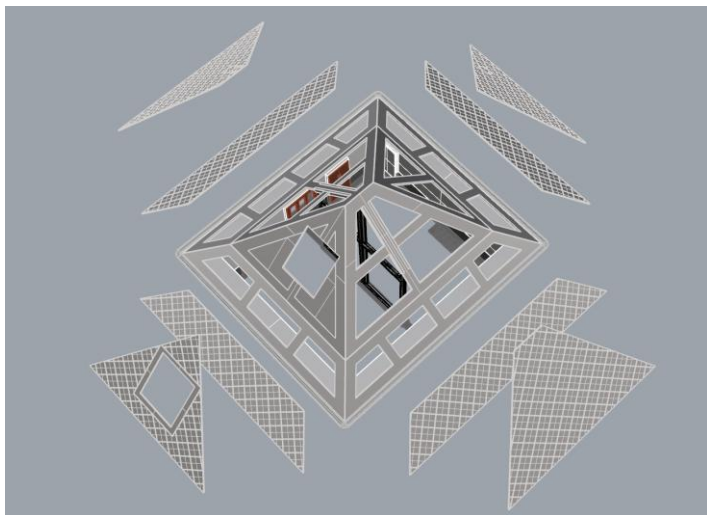
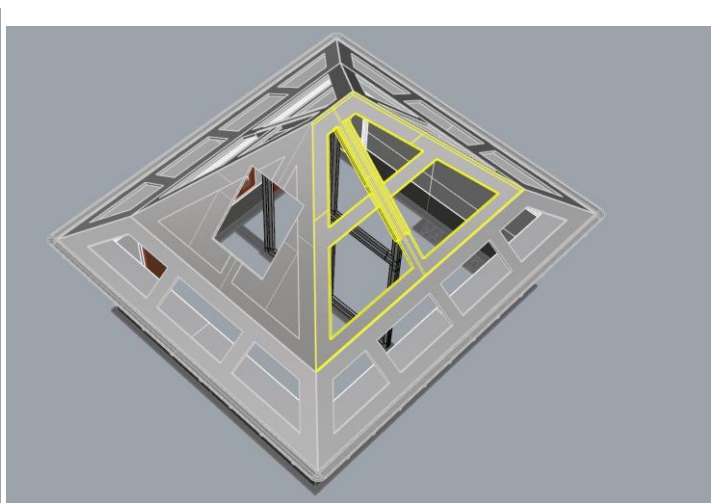
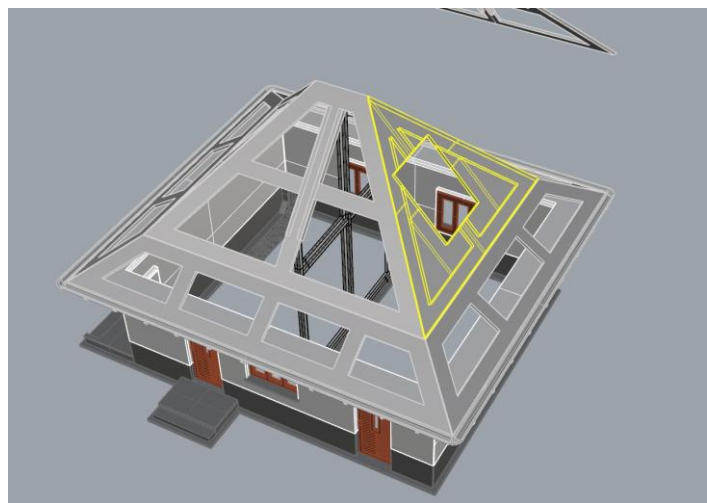
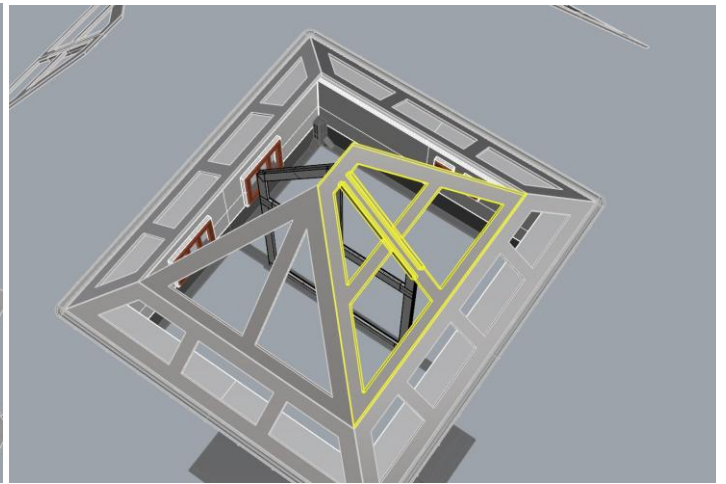
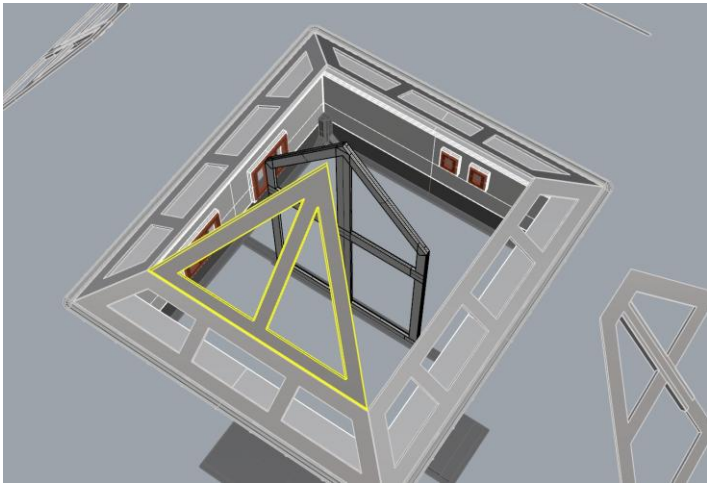

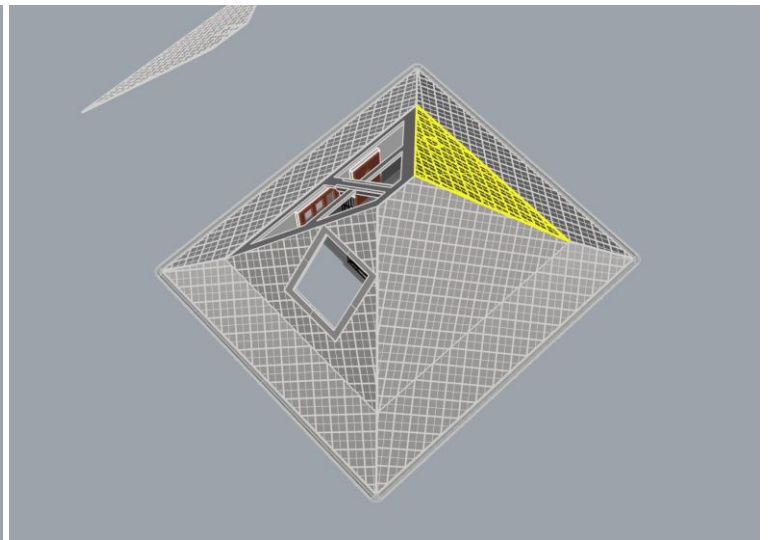
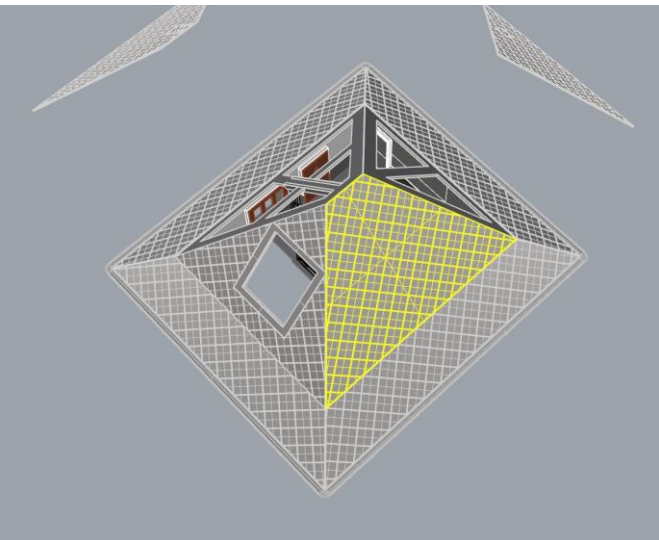
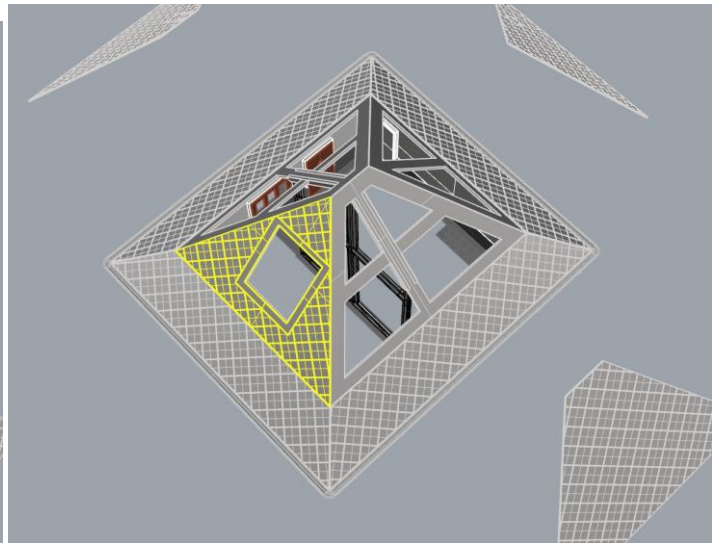
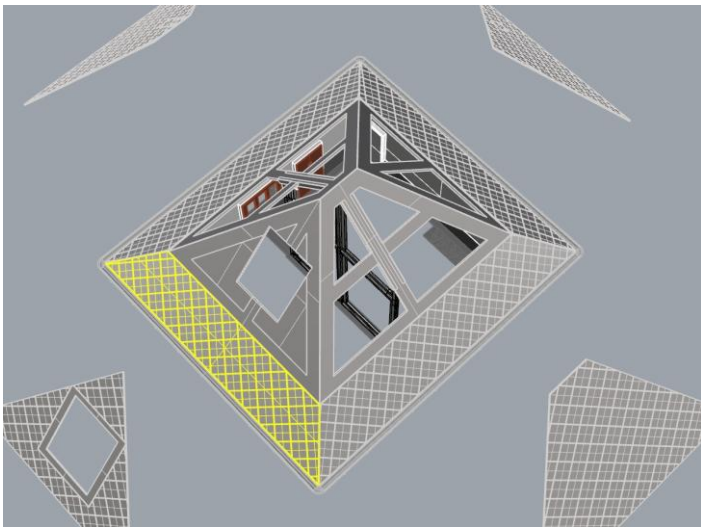
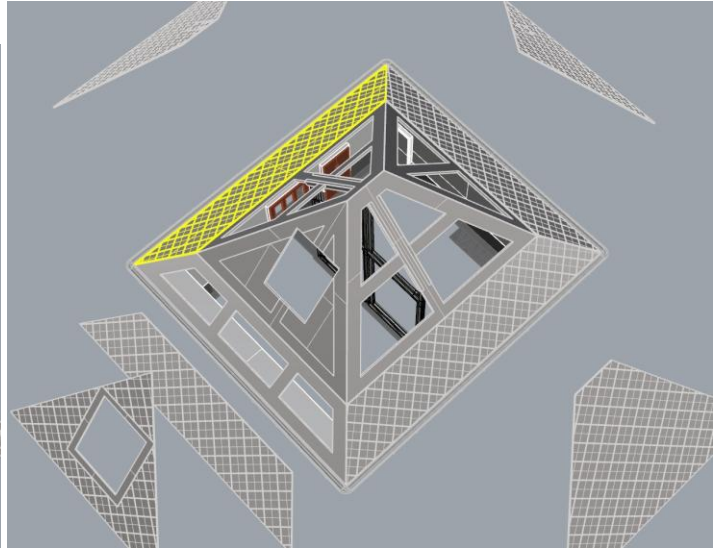
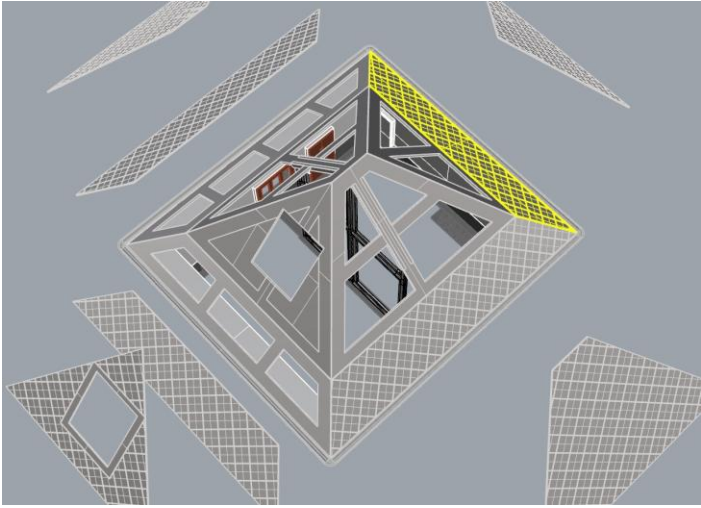

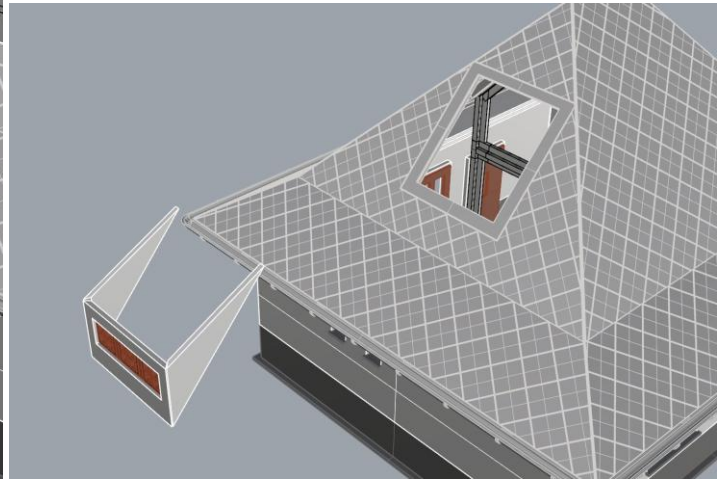
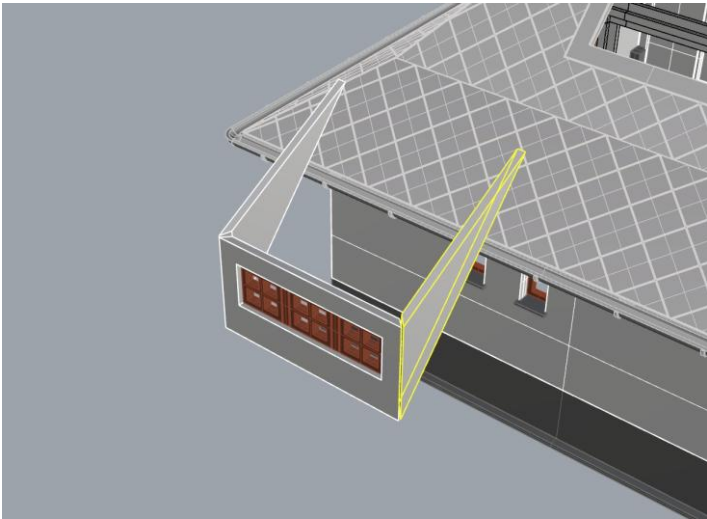
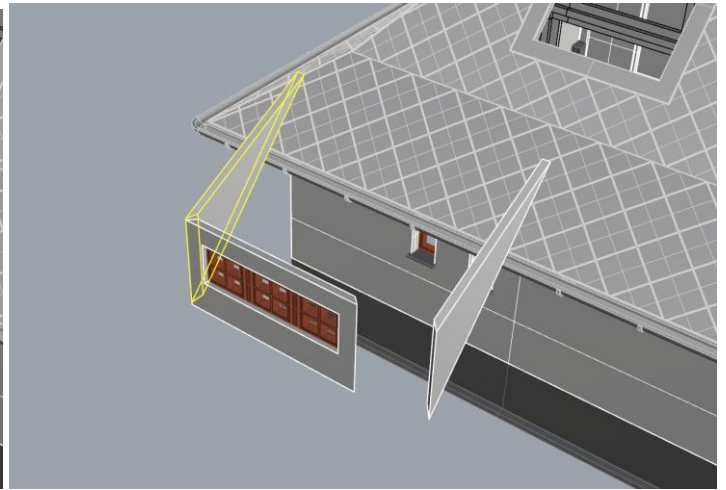
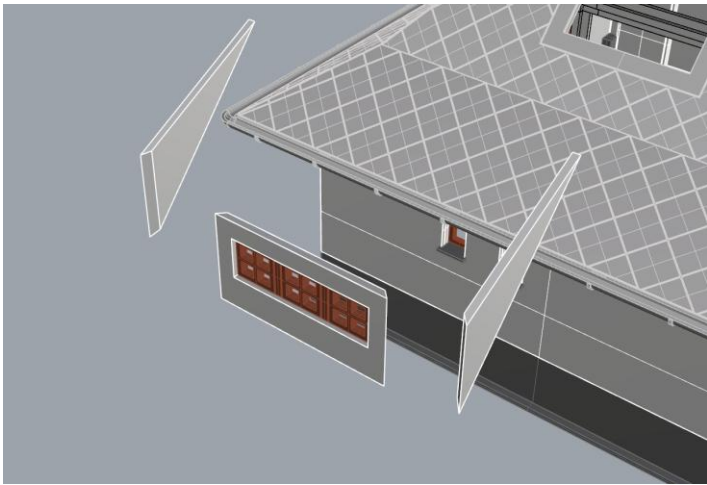
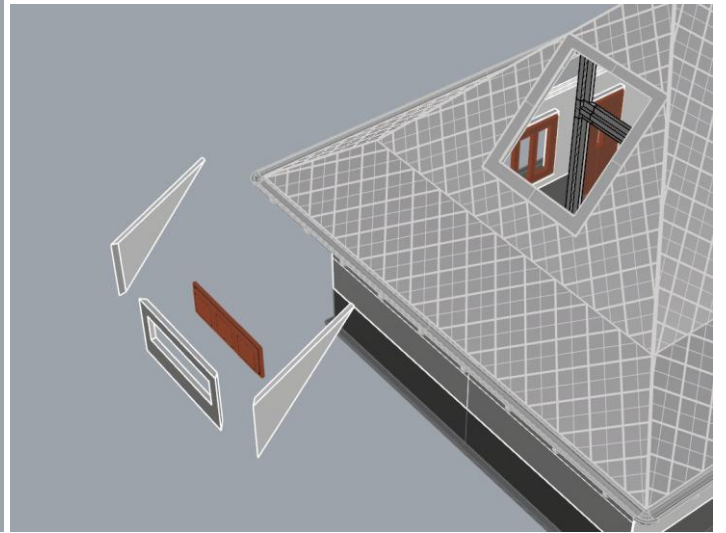
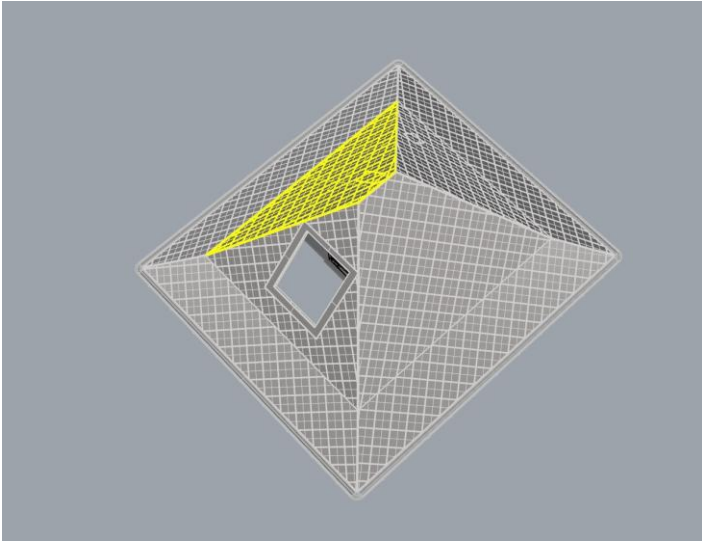

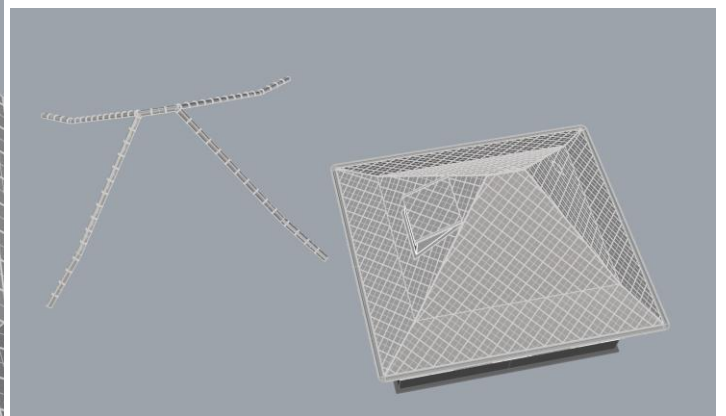
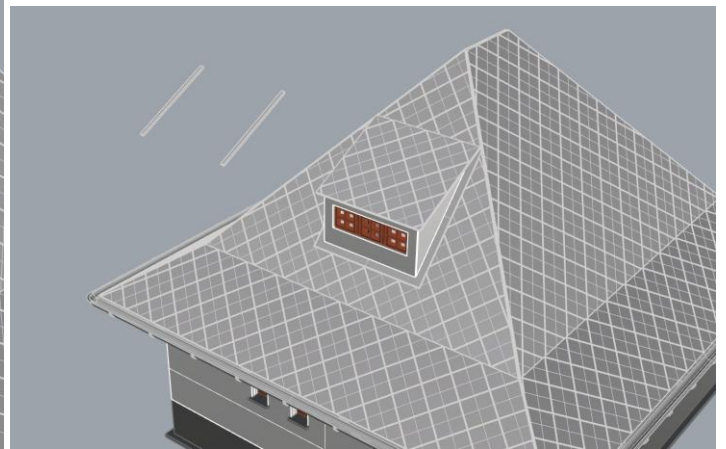
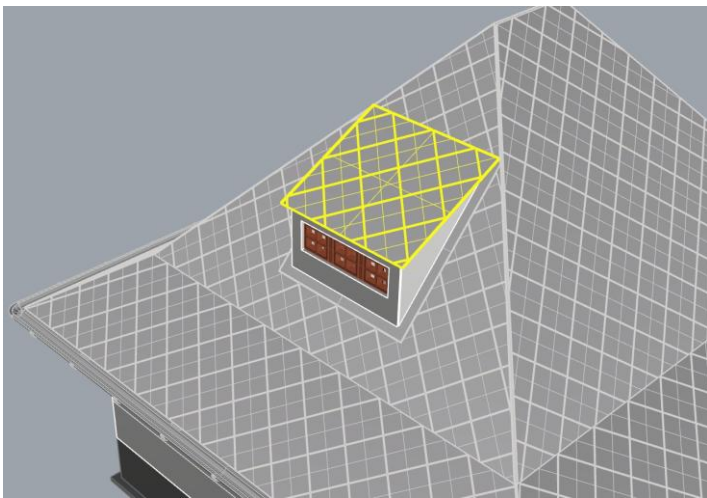
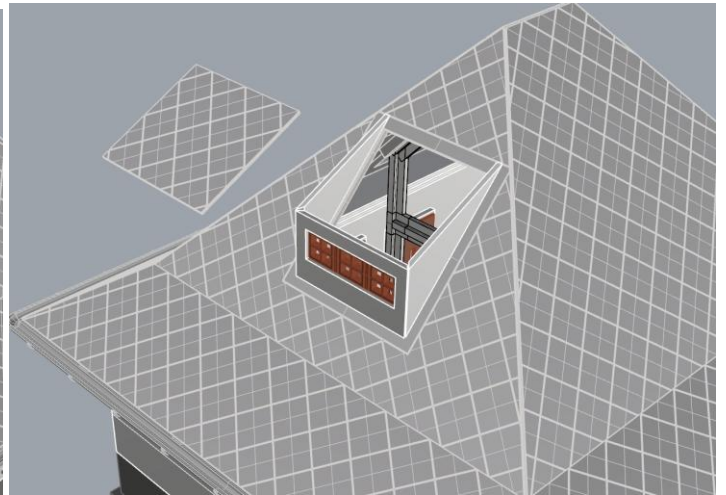
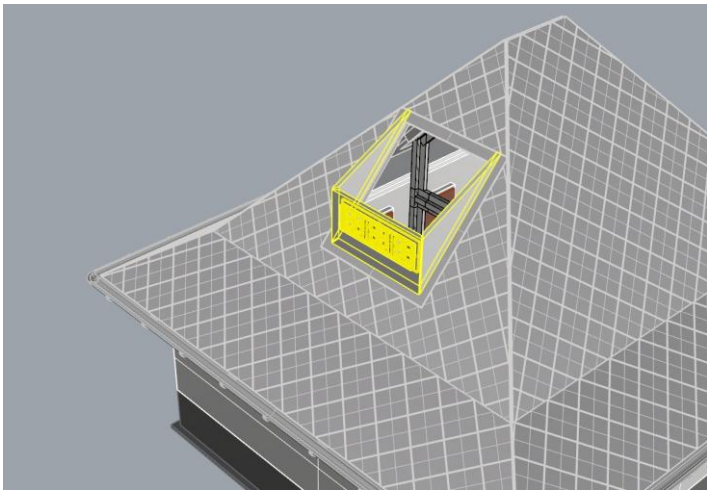

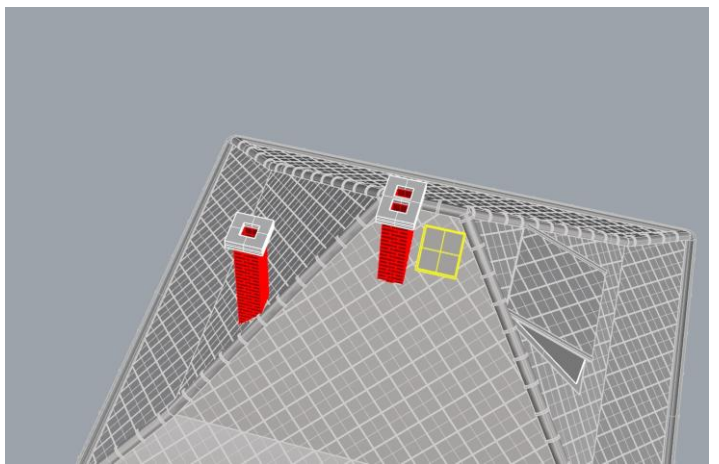
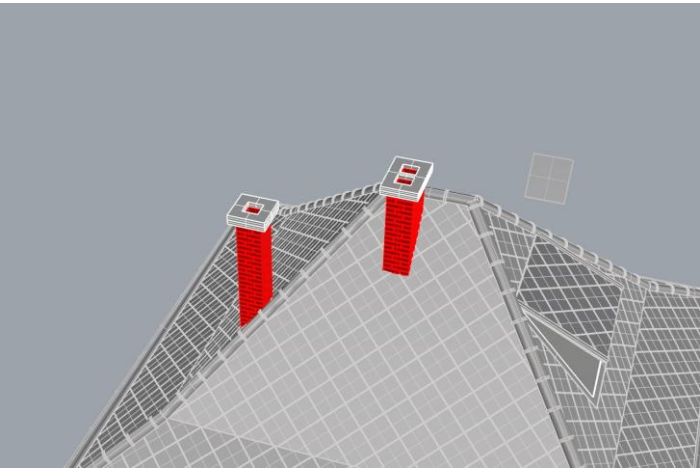
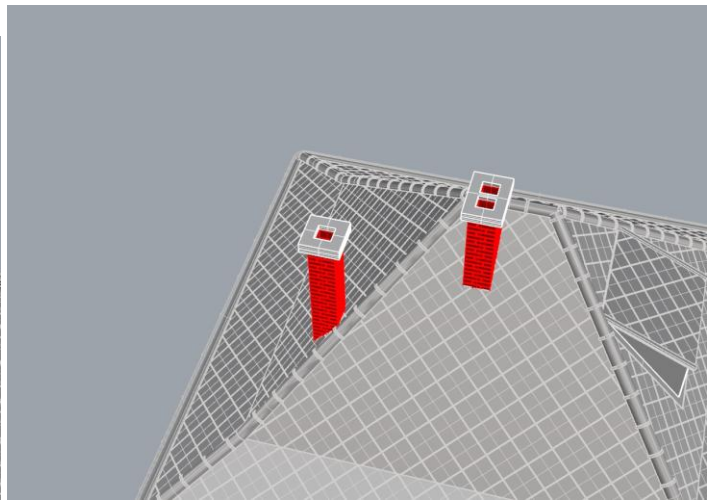
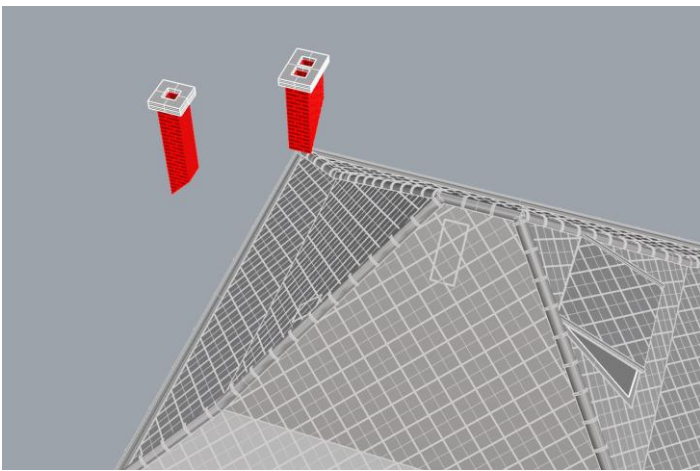
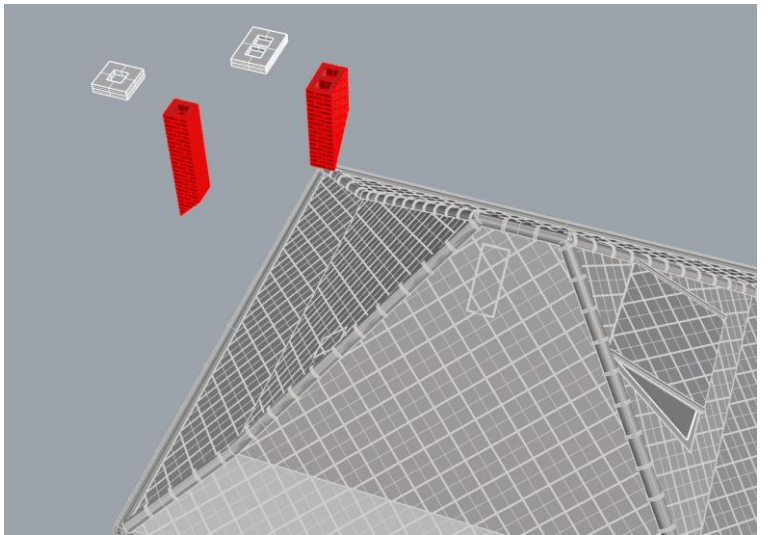
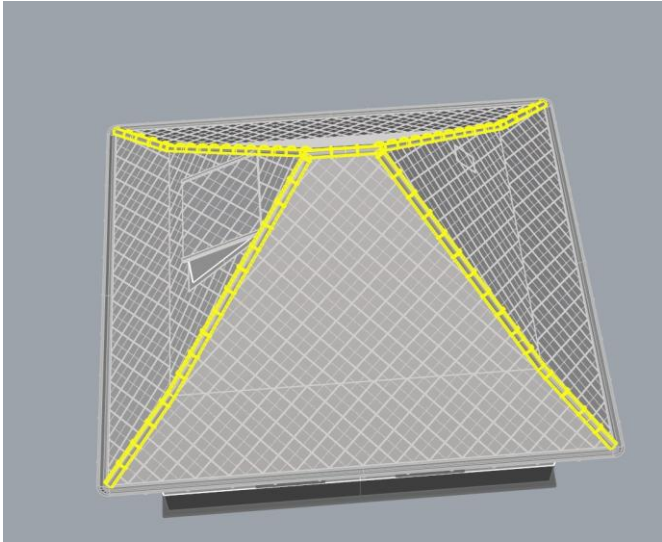

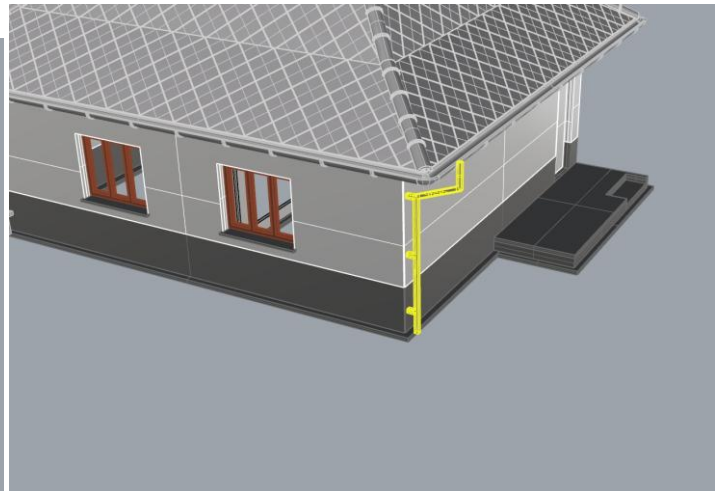
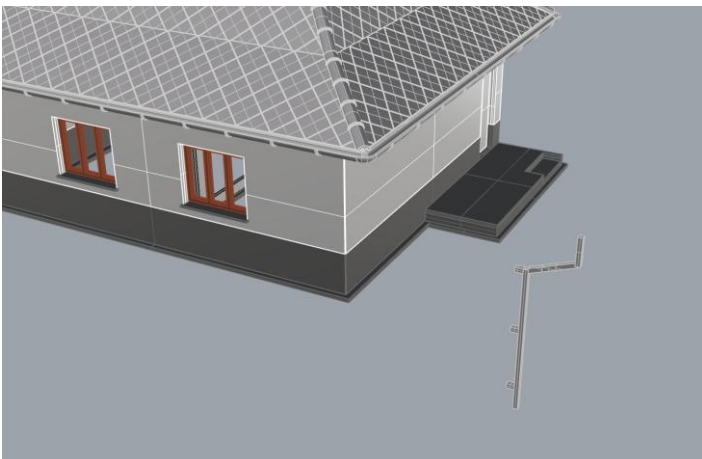
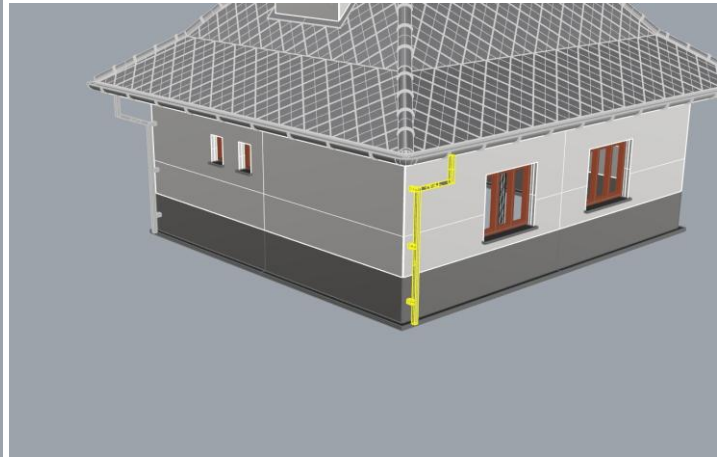
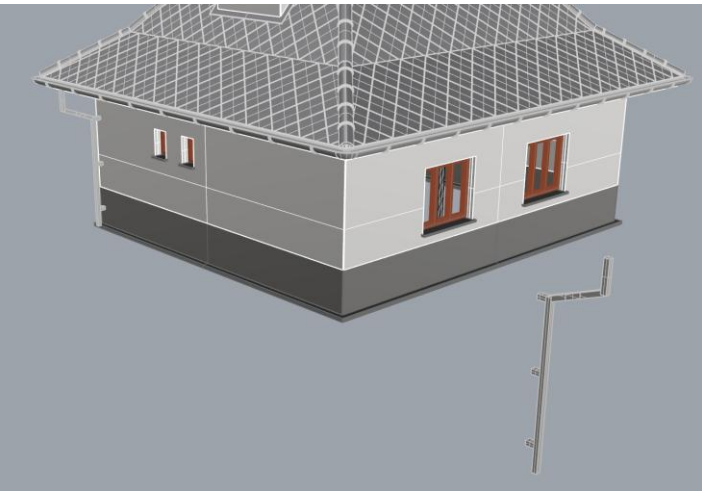
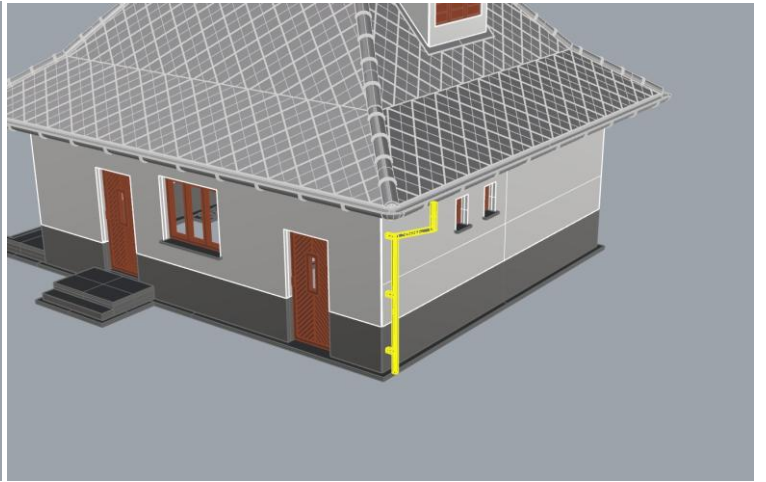
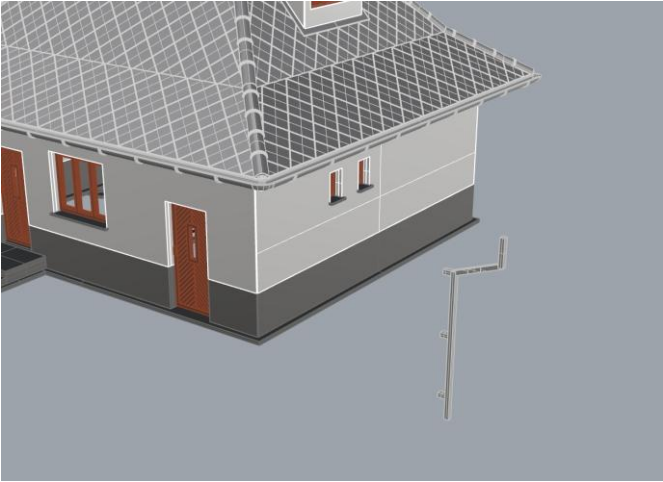

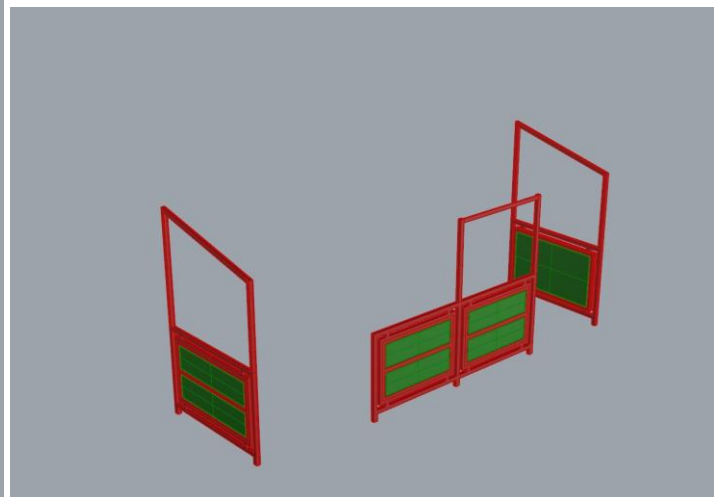
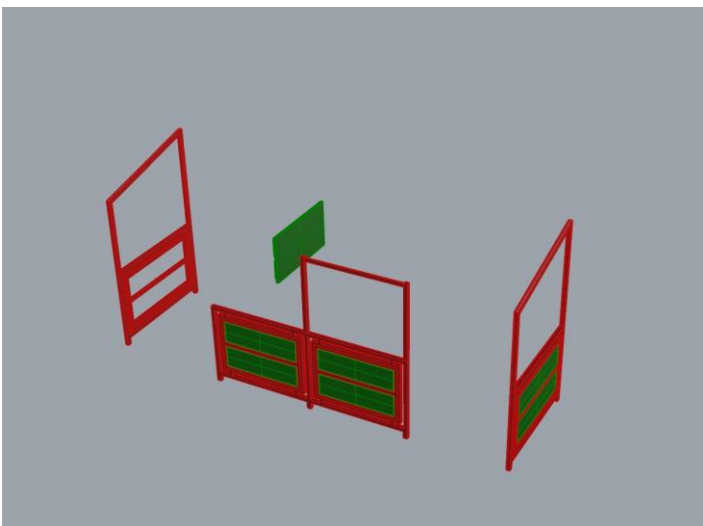
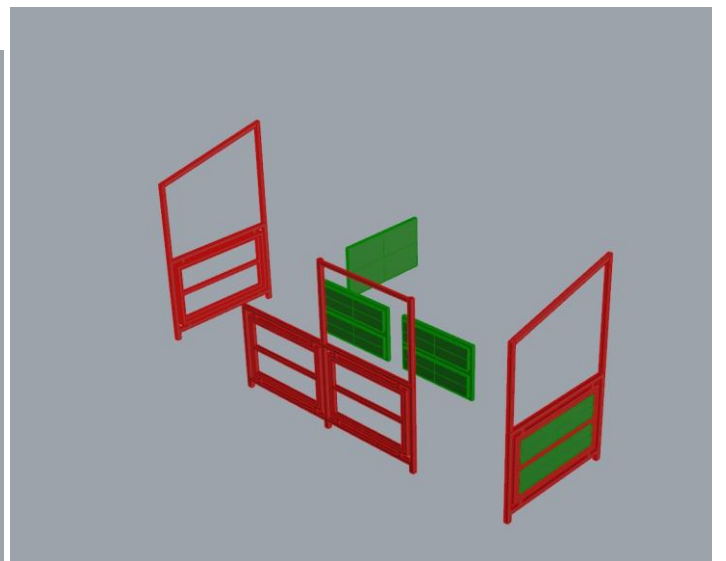
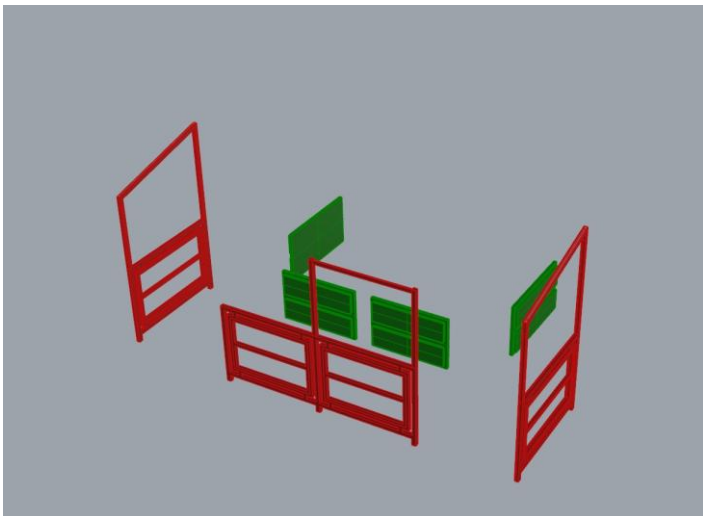
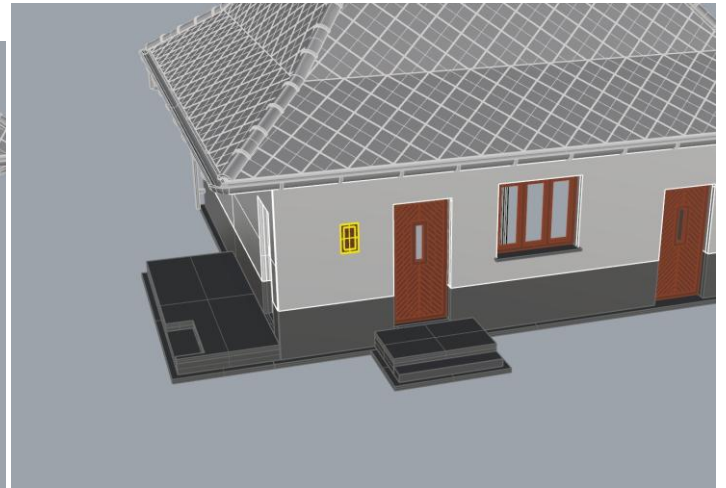
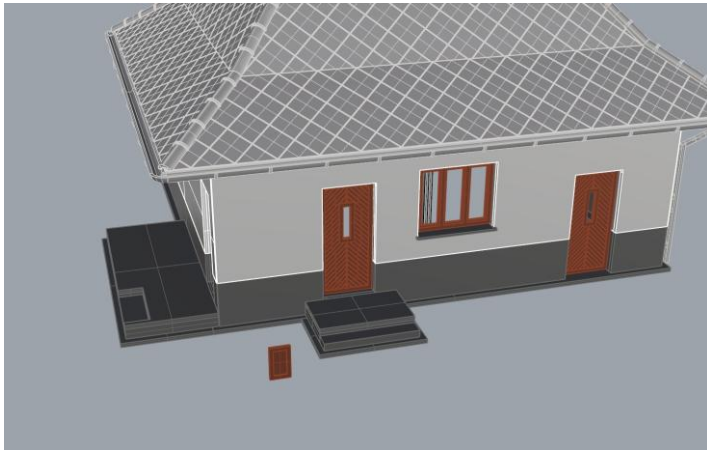

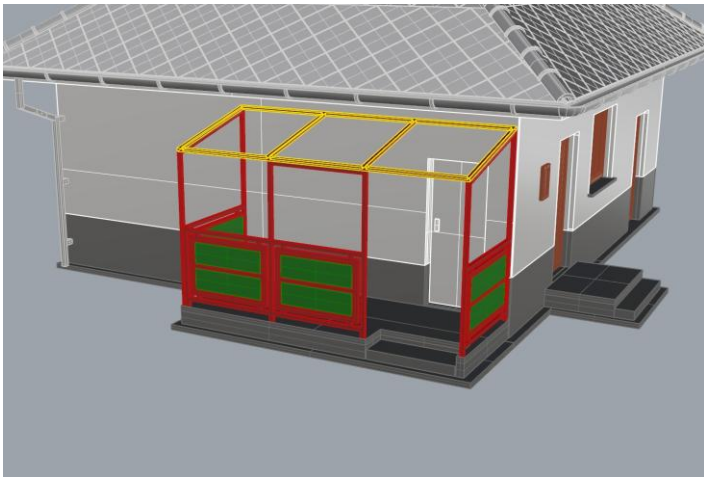
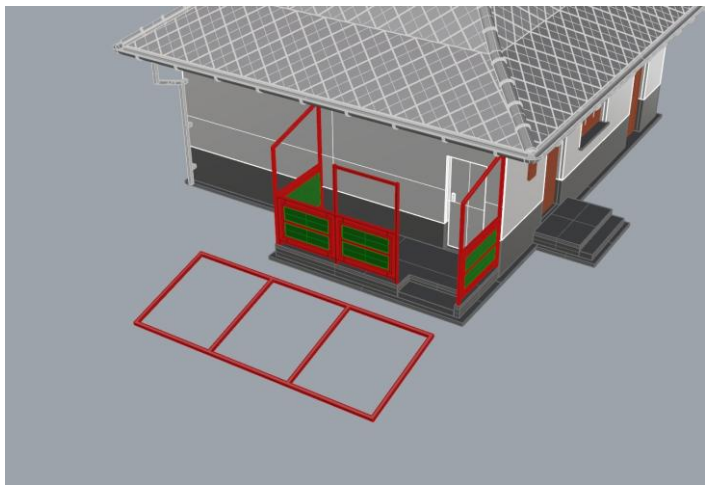
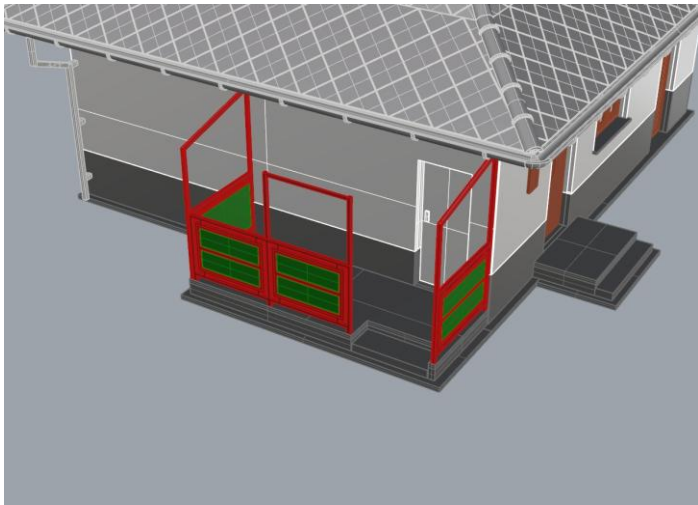
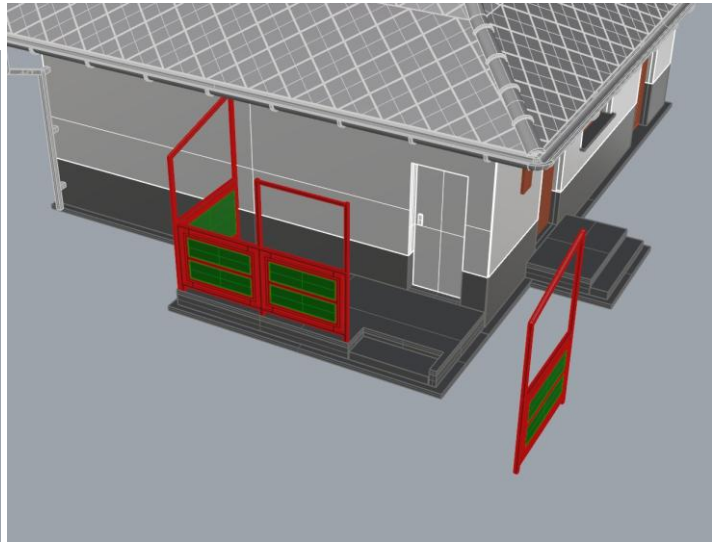
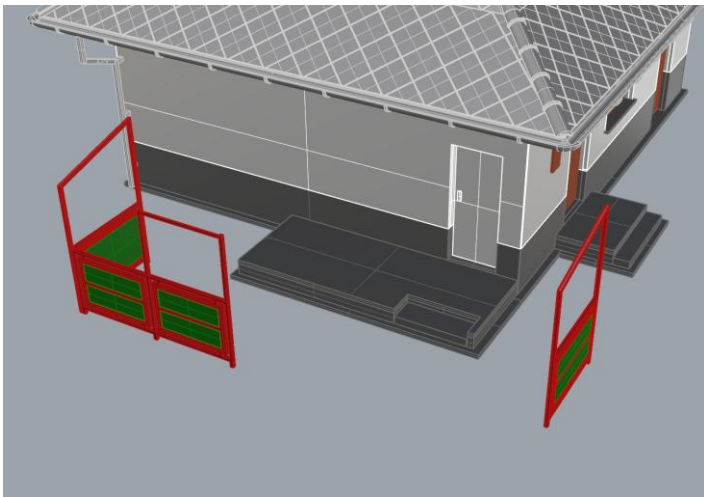

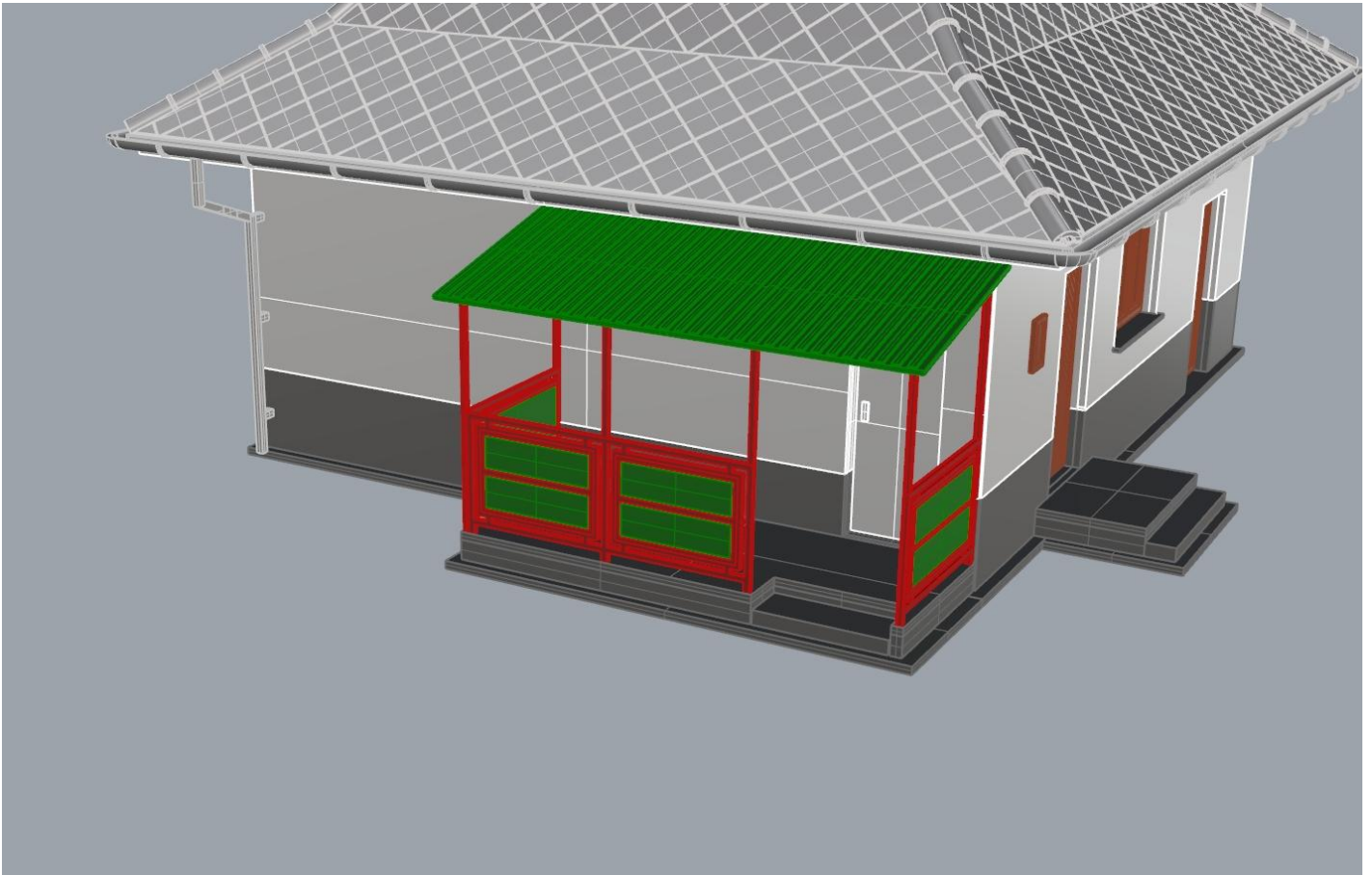

Készen is vagyunk.

