

VAMITTOOLS szimpla telefonfülke – 2212-es típus

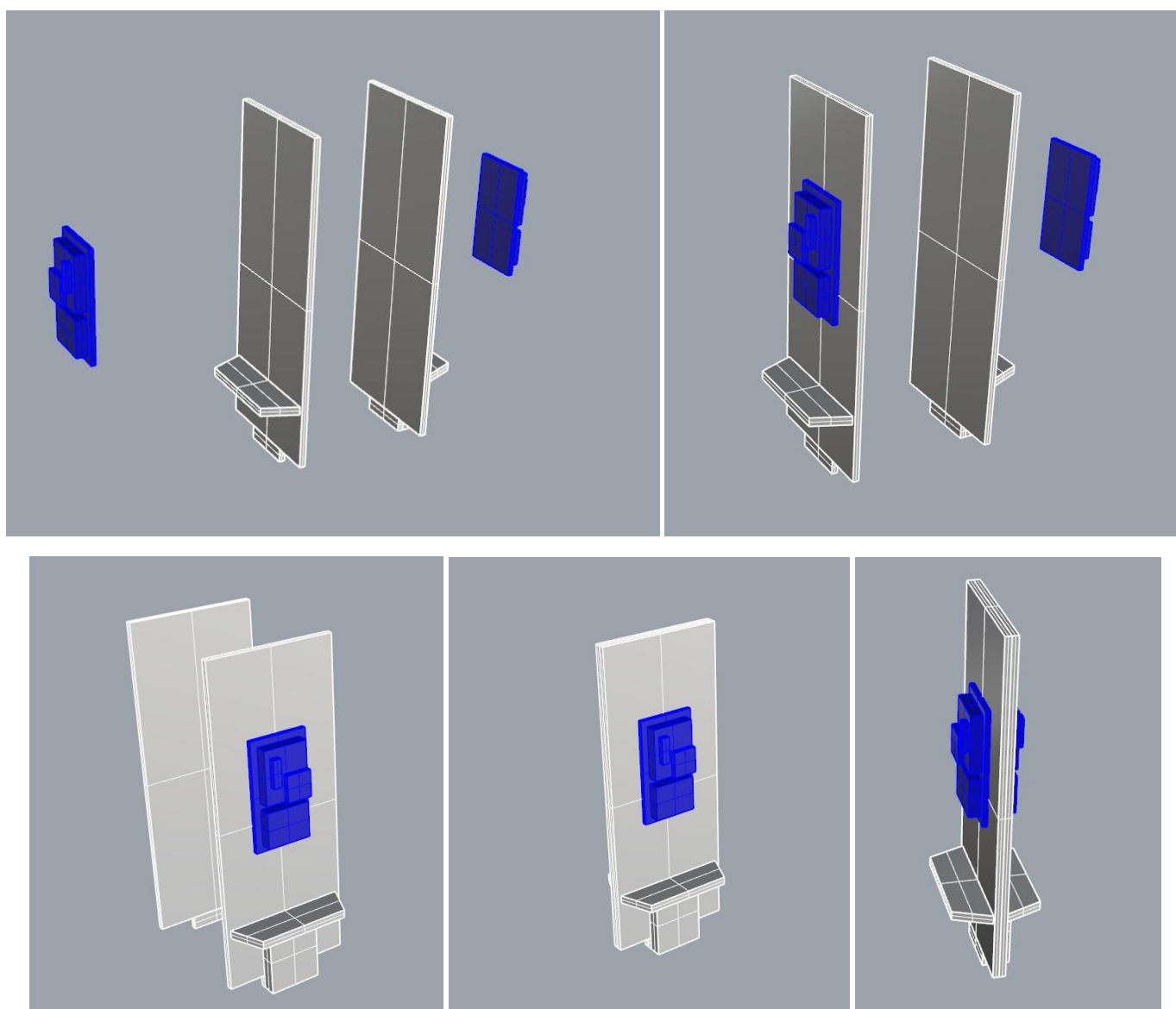

Az összerakást az oldalak külön-külön történő összerakásával kezdjük. Minden falrésznél a sima (fényes) oldal néz kifelé!
Kövessük a képeken látható lépéseket.

Hátoldal:



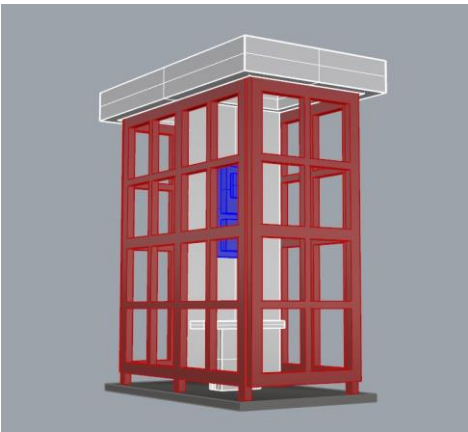
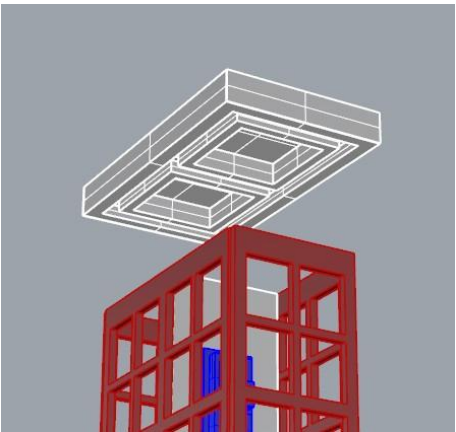
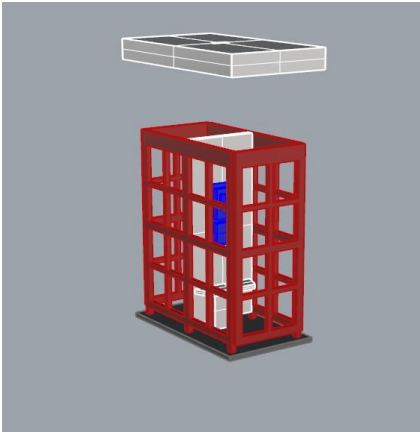
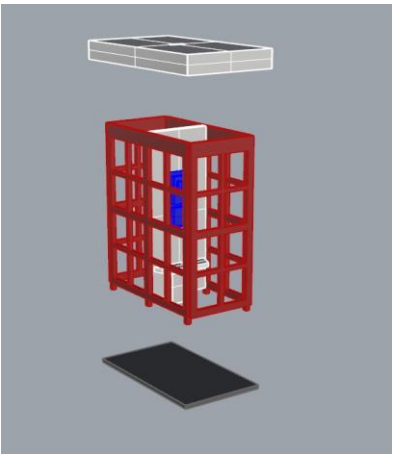
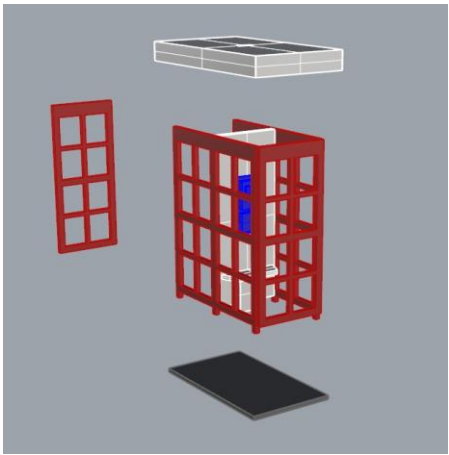
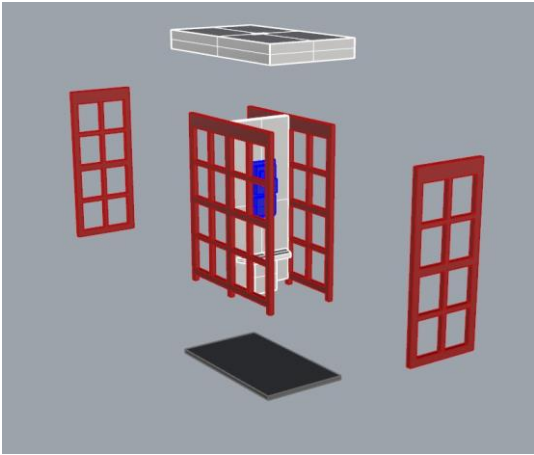
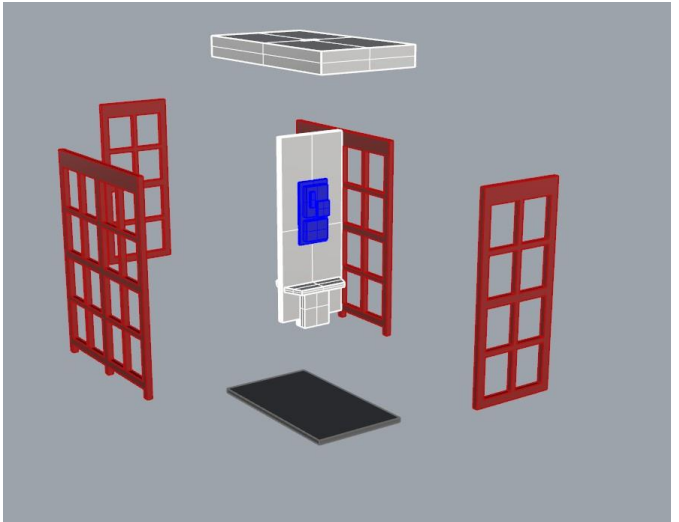
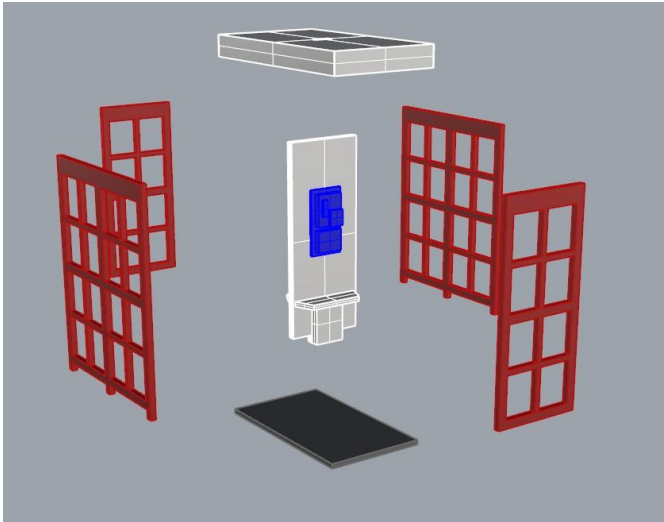

Az ajtóra kerülő fogantyút vágjuk méretre.

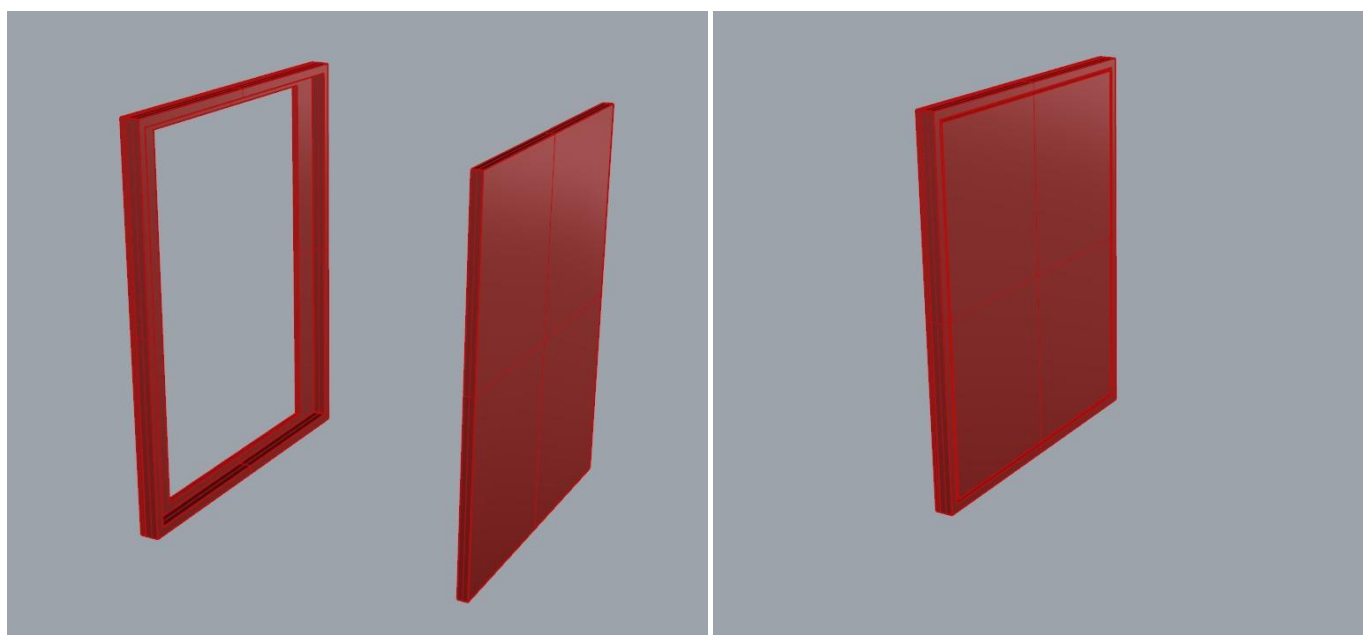
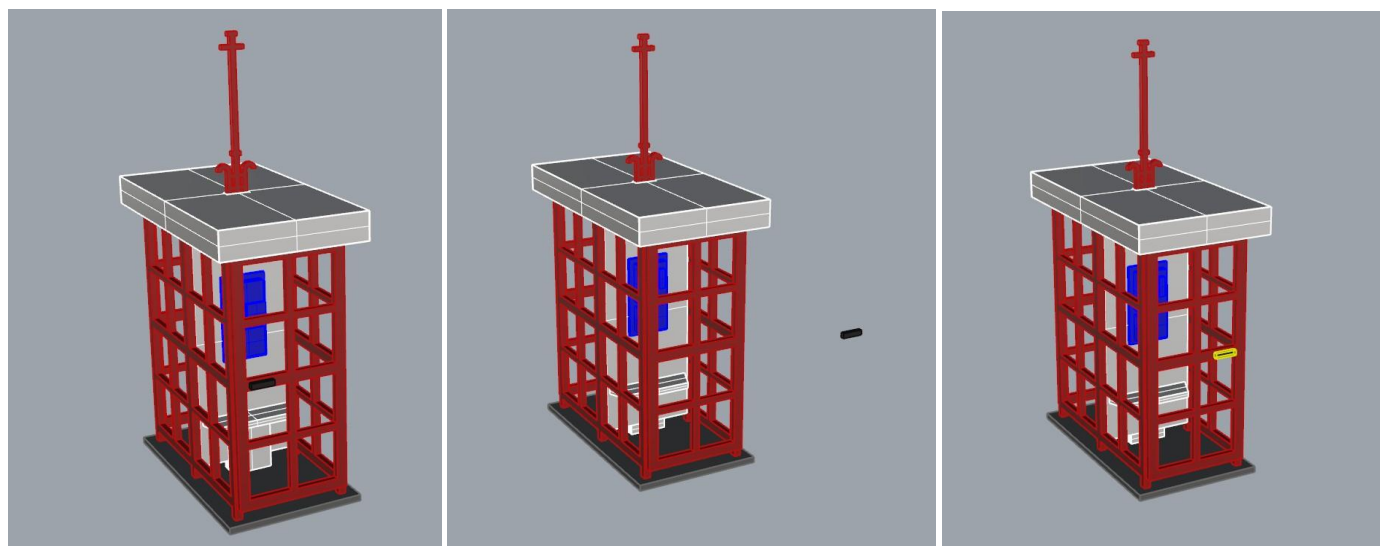
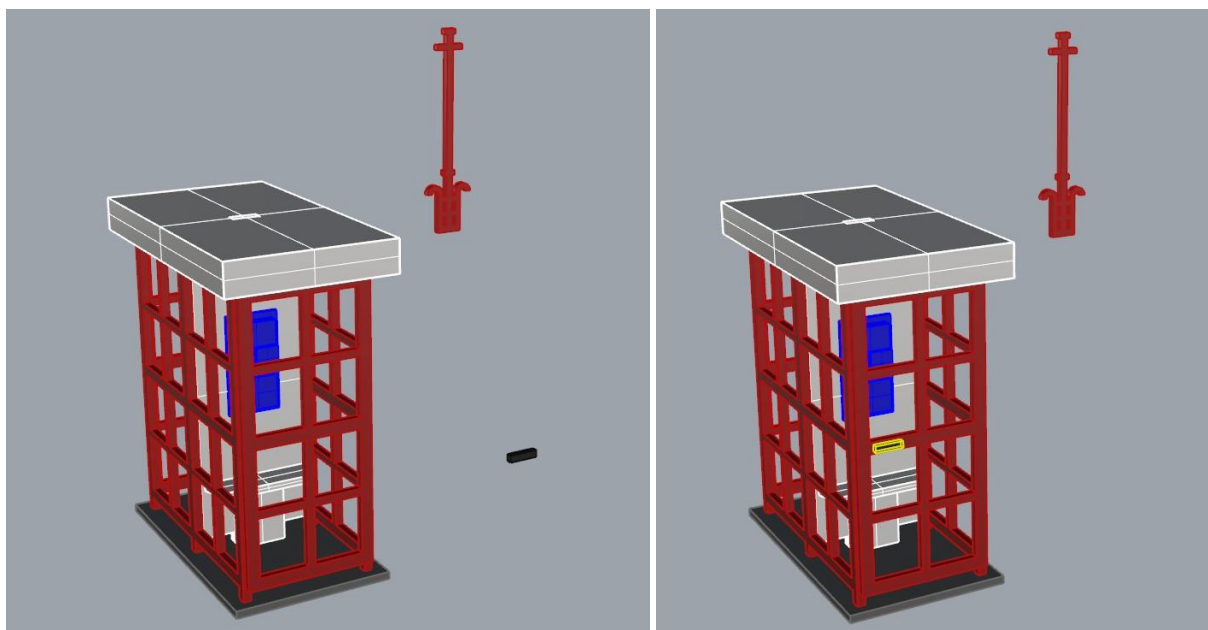

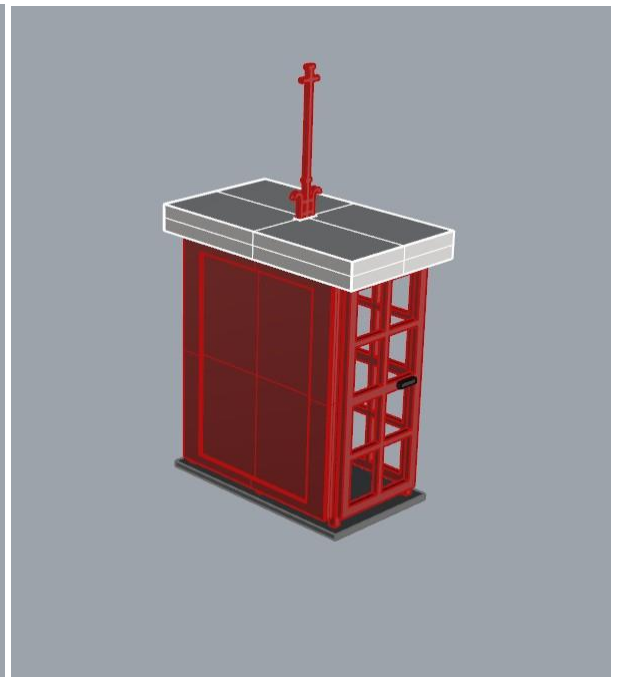
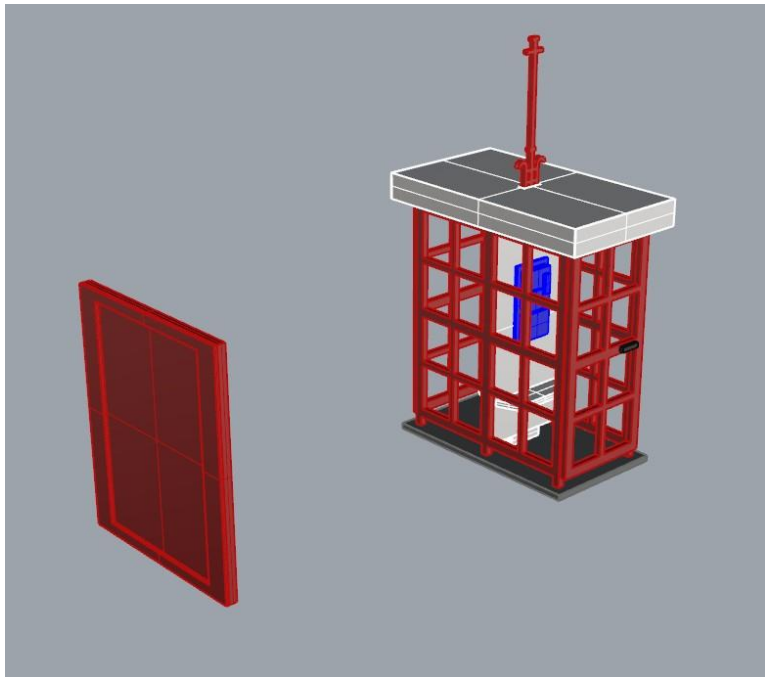

Készen is vagyunk.

